



# RESIDENTIAL & LIGHT COMMERCIAL SYSTEMS

---

**2019**



# ABOUT LG

---



## About LG Electronics USA

LG Electronics USA, Inc., based in Englewood Cliffs, NJ, is the North American subsidiary of LG Electronics, Inc., a \$48 billion global force and technology leader in consumer electronics, home appliances and mobile communications. LG Electronics, a proud ENERGY STAR® Partner of the Year, sells a range of stylish and innovative home entertainment products, mobile phones, home appliances, commercial displays, air conditioning systems and solar energy solutions in the United States, all under LG's "Life's Good" marketing theme. For more news and information on LG Electronics, please visit [www.LG.com](http://www.LG.com).

## LG Electronics USA Air Conditioning Technologies

The LG Electronics USA Commercial Air Conditioning business is based in Alpharetta, Ga. LG is a leading player in the global air conditioning market, manufacturing both commercial and residential air conditioners and providing total sustainability and building management solutions. From consumer and individual units to industrial and specialized air conditioning systems, LG provides a wide range of products for heating, ventilating and air conditioning. For more information, please visit [www.lghvac.com](http://www.lghvac.com).



---

## DUCT-FREE SYSTEMS: A NEW WAY TO THINK ABOUT AIR CONDITIONING

LG air conditioning systems  
are THE smart alternative to  
traditional air conditioning

---

For truly personalized comfort in all rooms, consider an LG Duct-Free Split air conditioning system. LG air conditioning systems make it easier to provide customized cooling and heating in every room without any bulky window units or costly ductwork, and with several indoor unit designs sure to match any décor, LG air conditioning systems can be right for every job.



### Our Commitment to You:

- QUALITY** LG air conditioning systems reflect our commitment to building high-quality products. Operating several state-of-the-art research & development facilities across the globe, LG invests heavily to ensure we are combining the best technologies with the best ideas.
- TRAINING** With several LG training academies throughout the United States and even more regional partner academies, LG makes it easy to learn about LG systems and product applications.
- PERFORMANCE** LG makes a wide range of duct-free products with powerful cooling and heating capabilities while maintaining high energy efficiencies, quiet operation, ease of use for personalization of comfort control for the end user.
- INNOVATION** LG utilizes smart technology to enhance a homeowner's, and the technician's, experience in operating and providing routine maintenance or service on our air conditioning systems. Our continued efforts to look for the most innovative ideas in HVAC, with our commitment to building green technologies, ensures that we will continue to develop and bring to market smarter, sustainable products.



# TABLE OF CONTENTS

---

## INTRODUCTION

---

About LG	1
LG Advantages	5
Training & Recognition	7
Installation Best Practices	8
Key Features	9

## SINGLE ZONE SYSTEMS

---

Wall Mounted	
- ART COOL™ Mirror	11
- ART COOL™ Premier	12
- Extended Piping	14
- High Efficiency	15
- Mega 208/230V	16
- Mega 115V	16
Ceiling Mounted	17
Low Static Ducted	18
High Static Ducted	19
Vertical AHU	20

## Multi-Zone SYSTEMS

---

Outdoor Units	23
Indoor Units	27
Multi F MAX Piping Accessories	31
Multi F Piping Summary	32

## ACCESSORIES

---

Controls	33
Indoor Accessories	34
Outdoor Accessories	35
Air Technologies	35

## REFERENCE TABLES

---

Controls & Accessories Compatibility	36
ENERGY STAR® Systems	38
Model Number Nomenclature	39



# LG ADVANTAGES



## ROOM-BY-ROOM CONTROL

With a controller for each indoor unit, LG air conditioning systems offer precise temperature settings in each zone while maximizing energy usage by heating or cooling only the zones in use.

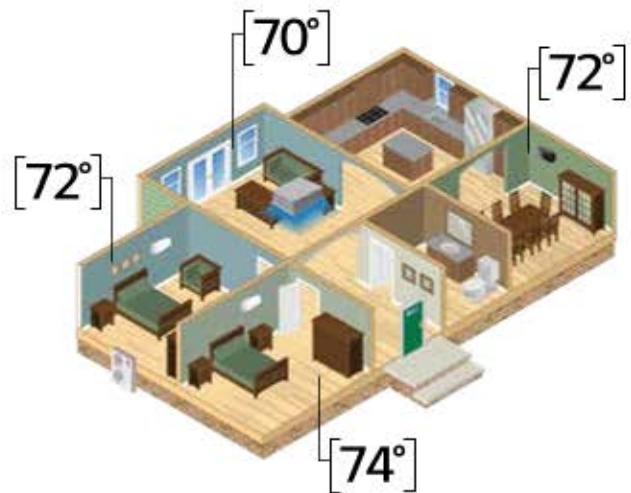

## QUIET OPERATION

LG duct-free systems operate at low sound levels, thanks to LG's unique low-vibration compressor, skew fan and brushless direct current (BLDC) motor technology that eliminates unnecessary noise and allows for smooth operation.

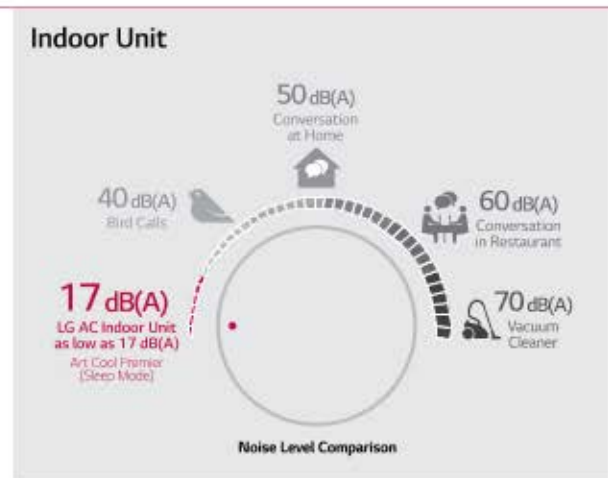

## INVERTER TECHNOLOGY

Inverter, variable-speed, compressor outdoor units use less energy and are measurably quieter than conventional air conditioner units. Unlike conventional systems that cycle on and off, an inverter compressor ramps up or down to match the capacity needed to maintain comfort levels selected by the homeowner within a conditioned zone.

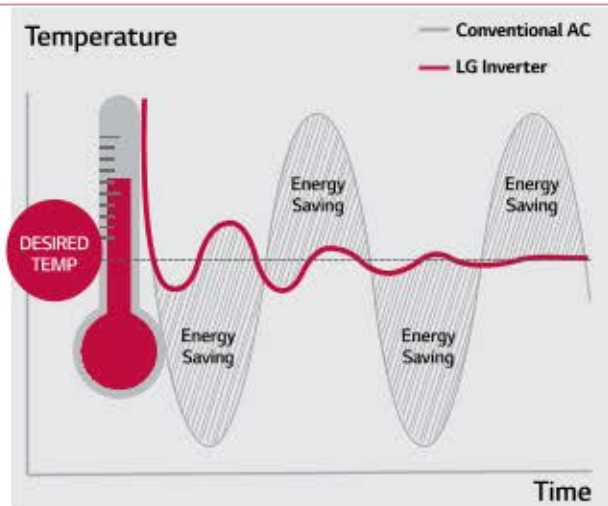

# LG ADVANTAGES



## LG SMARTTHINQ®

Whenever, wherever and no matter how many air conditioners you have, LG SmartThinQ® let you easily access and control your air conditioner from your compatible smart device.<sup>1</sup>



## EASY INSTALLATION & NO DUCTWORK

LG duct-free systems are designed for easier and more efficient installation. They require little to no ductwork, and most indoor units can mount on any wall. Installation requires only a small hole to be drilled in the wall. Smaller indoor and outdoor units ensure space-saving convenience. Moreover, long refrigerant piping lengths increase the distance between the indoor and outdoor units, allowing for extra installation and design flexibility.

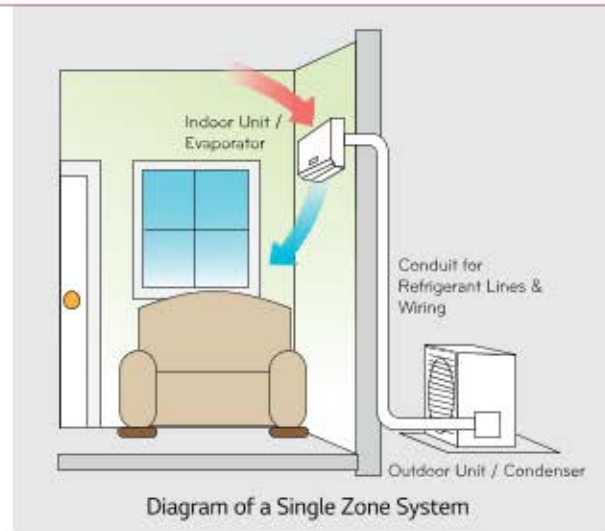

## AIR QUALITY

The LG duct-free indoor units utilize 3M Micro Protection Filters which reduce dust and microscopic particles including pollen, pet dander and odors. Additional primary filters are washable and antifungal, reducing life-time operation costs. Indoor units also self-clean the coil to protect against mold growth.

### Self-Cleaning Indoor Coil

The interior of the air conditioner is maintained by drying off the heat exchanger, eliminating unwanted mold and odors.



### MICRO Dust Filter Powered by 3M Tech

3M Micro Protection Filter, a high air flow filter with low noise, collects harmful microscopic substances including pollen and fine dust.



### Air Filter

This primary filter captures dust size over 10µm.



1. LG SmartThinQ® is only available for select models. See product details for full compatibility.

# TRAINING & RECOGNITION

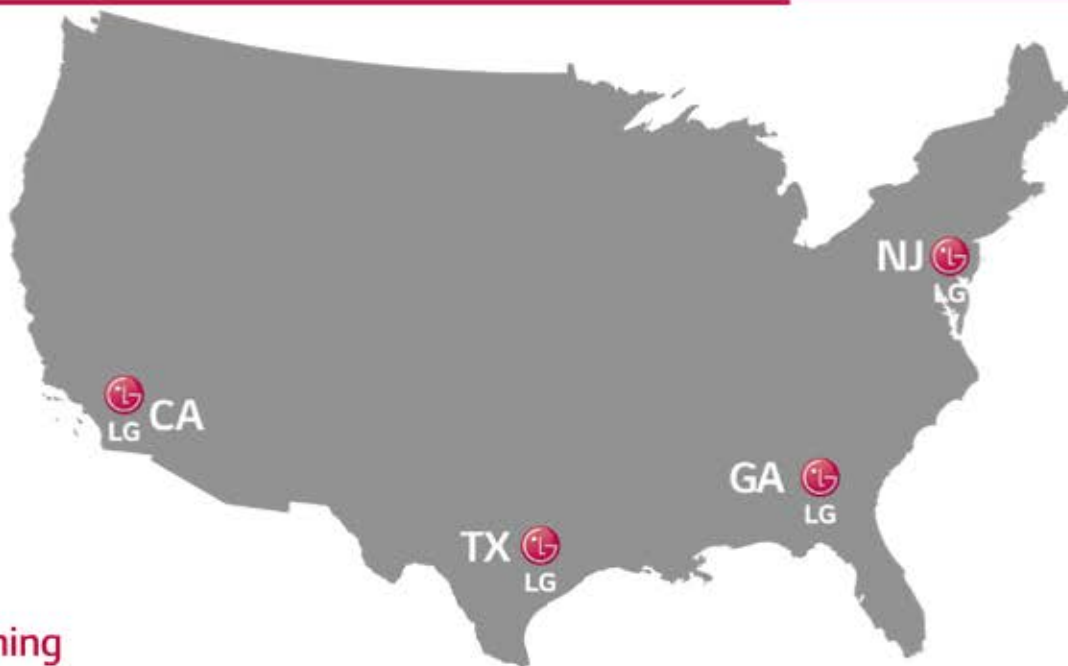

## Training

The LG US Air Conditioning Technologies division is headquartered near Atlanta in Alpharetta, Ga, along with a full training academy. Additional training academies are located in California, Texas and New Jersey. Since 2008, our academies have trained thousands on the advantages of LG air conditioning systems, and even more have been trained through LG's online training modules. Classes are taught by world-class trainers with years of experience in ductless technology with topics that cover everything from design and specification to installation and service.

For HVAC professionals, LG offers online instruction via our *Learning Management System* and classroom training at our training academies which are placed strategically placed throughout the country. Training is open to all contractors; ask your LG Electronics authorized distributor for details.

For more information and to find out how you can be part of the next training class near you, visit [training.lghvac.com](http://training.lghvac.com)

## Service Tools

As part of our commitment to innovation, LG has developed innovative ways to enhance the service technician's experience during routine maintenance or service with these tools:

- **LG SIMS (Smart Inverter Monitoring System)** connects to select outdoor units and allows technicians to troubleshoot accurately by interfacing directly with the unit and following step-by-step troubleshooting guidelines. This is a free smartphone app developed by LG factory engineers.
- **LG Telepresence** connects technicians in the field directly to LG Technical Assistance representatives via a live video feed through the technician's smartphone, allowing you to bring LG technical support with you to any jobsite.



### TAKE YOUR BUSINESS TO NEW LEVELS

The LG Excellence Contractor Program provides specialized support and recognition for contractors who have been trained by factory teams to install LG Residential and Light Commercial Systems, helping to set you apart from your competitors. Along with great incentives and recognition, the LG Excellence Contractor Program provides an enhanced warranty, a website listing with LG Excellence designation on the LG website's contractor locator, consumer lead referrals and local advertising materials. To find out how to put these tools to work for you, visit [lghvac.com/excellence](http://lghvac.com/excellence)



# INSTALLATION BEST PRACTICES

For jobs small to large, look for opportunities to use LG comfort systems everywhere! Explore the many applications of LG Single and Multi-Zone systems: whole home renovations, older system replacements, home additions, energy savings opportunities, hot or cold zones ... and many, many more!

System sizing and installation accuracy are key factors for the optimal performance of a LG comfort system. Increased energy efficiency, customizable design aesthetics and room by room comfort control are just a few of the benefits that come from a properly installed system.

Below are a few of the best practices used by *Excellence Contractors* across the U.S. during installation:

## Unit Placement (Indoor & Outdoor)

- Leave appropriate clearances on all sides of the indoor and outdoor units to allow for proper airflow as well as service access
- Include space for drainage to ensure condensate flows properly out of the unit
- Units should be properly anchored to prevent unnecessary vibrations

### *Additionally for indoor units:*

- Keep unit away from any indoor steam or excessive heat
- No obstacles should be placed around unit
- Do not install near a doorway or over a window
- Condensation drain should be routed away from the indoor unit to the outside

## Wiring

- Use wire that fulfills or exceeds the minimum wire requirements:
  - Multi F MAX to BD unit: 16-4
  - All other wiring: 18-4
- L1 and L2 are polarity sensitive on all models
- Indoor units are 208/230 volts (or 115 volt on two Mega models)
- Terminal 3 is 115 volt
- Never use wire nuts or splices in wiring
- Use non-insulated spade connectors on all terminal connections
- Use a JIS screwdriver on terminal block to avoid stripping out the screws
- Only a dedicated electrical circuit is allowed
- Always ground indoor and outdoor unit
- Only connect one (1) end of the shielded cable if using shielded wire

**\*NOTE\* All wiring must comply with applicable local and national codes.**

## Piping

- Use only the correct line sizes as determined by the indoor unit
- Use only copper refrigerant piping
- Insulate both refrigerant lines independently of each other
- Flare connections using a 45-degree flaring tool
- Consider Flaretite fittings for all connections and torque flares to specs
- Do not exceed the maximum pipe length or install less than the required minimum
- Do not make vertical loops in the refrigerant piping
- Support pipe runs from sagging or bending

## Charging

- Leak test with dry nitrogen to at least 550 p.s.i.
- Never use anything but soap bubbles designed for HVAC leak testing
- Use only an approved evacuation hose for proper evacuation and leak testing
- If possible, remove cores from system prior to starting evacuation
- Start with fresh vacuum pump oil and evacuate to less than 500 microns
- If refrigerant is added, use an electronic scale and weigh in the precise amount
- Open service valves prior to energizing the unit

## Installation and Service Tools:

- Quality Flaring Tool
- Digital Refrigerant Charging Scale
- Torque Wrench
- JIS Screwdriver
- Micron Gauge
- Vacuum Pump
- High-Quality Multimeter



# KEY FEATURES



## LGRED<sup>®</sup> HEAT TECHNOLOGY

Advanced technology that can exceed 100% of the rated heating capacity performance down to 5° F and continuous heating performance down to -13° F.

**LGRED<sup>®</sup>**  
Powerful Heat Technology  
RELIABLE TO EXTREME DEGREES



## DEHUMIDIFYING MODE

Uses sensors in the indoor unit to accurately measure room temperature and control humidity by adjusting the set point and fan speed.



## OPTIMIZED AIRFLOW



**Jet Cool / Jet Heat Mode** operates the unit at a high speed for up to 30 minutes to quickly cool or heat a room.



**Swirl Wind / Chaos Wind** allows for customized louver and fan speed operation to create a stronger, wider airflow for reduced temperature stratification and to provide more natural air circulation.



**Auto Operation** adjusts the temperature and fan speed automatically to match the user's preference from three levels of comfort.



**Art Cool Gallery 3D Airflow** uniquely provides three-directional airflow for more natural and effective air circulation.



## GOLD FIN

**Gold Fin™ Coating** is an anticorrosion coating to help protect your system from corrosive elements, allowing the coil to maintain excellent heat transfer properties for an extended time.



## DEFROST CONTROL

Removes frost from the outdoor coil when ambient outdoor temperatures are low and simultaneously shuts down the indoor fan to prevent cold air from being blown into the controlled space.



## AUTO SLEEP MODE

Automatically increases the temperature setting 2°F twice in 30 minute increments. The indoor unit shuts off when the timer setting is reached.



## AUTO RESTART

Automatically restarts the system after a power failure.





































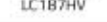



## STYLISH DESIGN

LG air conditioning systems come in a variety of indoor units, including the Art Cool™ Gallery, which includes a panel that works like a customizable picture frame. For Multi F systems, choose from different capacities to match load demands appropriately while maintaining the aesthetic of any room's décor.



# SINGLE ZONE SYSTEMS

## Lineup

		Btu/h	9,000	12,000	15,000	18,000	24,000	30,000	36,000	42,000	48,000
Wall Mounted	ART COOL™ Mirror										
		LA090HSV5	LA120HSV5			LA180HSV5	LA240HSV3				
	ART COOL™ Premier										
		LA090HYV1	LA120HYV1	LA150HYV2	LA180HYV2	LA240HYV1					
											
											
							LS243HLV	LS303HLV	LS363HLV		
Ceiling Mounted	High Efficiency										
		LS090HSV5	LS120HSV5			LS180HSV5					
	Mega 208/230V										
		LS090HEV1	LS120HEV1			LS180HEV1	LS240HEV1				
											
	LS090HXV	LS120HXV									
Ducted	Ceiling Cassette					 					
		LC098HV4	LC128HV4			LC188HV4 LC187HV	LC247HV		LC367HV	LC427HV	
	High Static										
						LH247HV		LH367HV			
	Low Static										
		LD097HV4	LD127HV4			LD187HV4					
	Vertical AHU										
						LV180HV4	LV240HV4		LV360HV4	LV420HV	LV480HV



# ART COOL™ MIRROR



LA090HSV5  
LA120HSV5  
LA180HSV5  
LA240HSV3



Specification	Unit	LA090HSV5	LA120HSV5	LA180HSV5	LA240HSV3 <sup>1</sup>	
Indoor Unit		LAN090HSV5	LAN120HSV5	LAN180HSV5	LAN240HSV3	
Outdoor Unit		LSU090HSV5	LSU120HSV5	LSU180HSV5	LSU240HSV3	
Capacity <sup>1,2</sup>	Rated Cooling Capacity	Btu/h	9,000	12,000	18,000	22,000
	Cooling Capacity Range	Btu/h	1,023 - 12,625	1,023 - 13,785	3,070 - 29,515	3,070 - 30,030
	Rated Heating Capacity	Btu/h	10,900	13,600	21,600	27,600
	Heating Capacity Range	Btu/h	1,023 - 17,061	1,023 - 22,178	3,070 - 38,898	3,070 - 38,898
	Max Heating Capacity at 17°F	Btu/h	11,080	13,810	22,340	28,020
	Max Heating Capacity at 5°F	Btu/h	9,570	11,930	19,300	24,220
	Max Heating Capacity at -4°F	Btu/h	8,310	10,360	16,760	21,030
	SEER, EER	Btu/h	23.5, 14.52	22.7, 12.5	21.5, 12.58	20.0, 10.8
Power	HSPF		11.3	11.4	10.2	10.0
	Voltage (IDU)	V-Ø - Hz	208/230-1-60	208/230-1-60	208/230-1-60	208/230-1-60
	Voltage (ODU)	V-Ø - Hz	208/230-1-60	208/230-1-60	208/230-1-60	208/230-1-60
	Cooling Power Input	kW	0.62	0.96	1.43	2.04
	Heating Power Input	kW	0.71	1.04	1.73	2.67
	MCA, MOCP	A	10, 15	10, 15	13, 20	19, 25
	Power/Communication Wiring <sup>3</sup>	No. x AWG	4 x 18	4 x 18	4 x 18	4 x 18
	Rated Amps (Cool/Heat)	A	7.4/7.4	7.4/7.4	9.85/9.85	15.4/15.4
Operation Range	Heating Operation Range	°F WB	-4 - 65	-4 - 65	-4 - 65	-4 - 65
	Cooling Operation Range	°F DB	14 - 118	14 - 118	14 - 118	14 - 118
	Optional Wind Baffle <sup>4</sup>		ZLABGP01A (0°F)	ZLABGP01A (0°F)	ZLABGP02A (0°F)	ZLABGP02A (0°F)
	IDU Operation Range Cooling	°F	53 - 75	53 - 75	53 - 75	53 - 75
	IDU Operation Range Heating	°F	60 - 86	60 - 86	60 - 86	60 - 86
	Setpoint Range Cooling	°F	64 - 86	64 - 86	64 - 86	64 - 86
	Setpoint Range Heating	°F	60 - 86	60 - 86	60 - 86	60 - 86
	Dimensions	IDU Dimensions (WxHxD)	in	32-15/16 x 12-1/8 x 7-9/16	32-15/16 x 12-1/8 x 7-9/16	39-9/32 x 13-19/32 x 8-11/32
ODU Dimensions (WxHxD)		in	30-5/16 x 21-3/2 x 11-5/16	30-5/16 x 21-1/2 x 11-5/16	34-1/4 x 31-1/2 x 12-19/32	34-1/4 x 31-1/2 x 12-19/32
Weight	IDU Weight (Net/Shipping)	lbs	20.5 / 25.6	20.5 / 25.6	29.8 / 36.4	32/39
	ODU Weight (Net/Shipping)	lbs	74.1 / 78.9	74.1 / 78.9	116.9 / 126.5	121/131
Unit Data	Airflow (Max/H/M/L) <sup>5</sup>	CFM	459 / 338 / 317 / 194	459 / 338 / 317 / 194	706 / 530 / 477 / 371	735/622/509/399
	Dehumidification	pts/hr	2.7	2.7	5.5	5.5
	Compressor Type		Twin Rotary	Twin Rotary	Twin Rotary	Twin Rotary
	Refrigerant Type		R410A	R410A	R410A	R410A
Sound Pressure <sup>6</sup>	Indoor (H/M/L/SL)	dB(A)	39 / 33 / 23 / 19	39 / 33 / 23 / 19	45 / 40 / 35 / 29	45/40/35/29
	Outdoor Max	dB(A)	48	48	53	53
Piping <sup>7</sup>	Liquid Pipe	in	1/4	1/4	3/8	3/8
	Vapor Pipe	in	3/8	3/8	5/8	5/8
	Pipe Length (Min/Max)	ft	9.8 / 82	9.8 / 82	9.8 / 114.8	9.84/98.4
	Max Pipe Elevation	ft	49.2	49.2	49.2	49.2
	Precharge Pipe Length	ft	41	41	24.6	24.6
	Additional Refrigerant	oz/ft	0.22	0.22	0.38	0.38
	Drain (OD, ID)	in	27/32, 5/8	27/32, 5/8	27/32, 5/8	27/32, 5/8
Controller	Supplied		AKB74955602	AKB74955602	AKB73835320	

Note:

- Rated capacity at 0 ft. above sea level with 25 ft. of refrigerant line and a 0 ft. level difference between outdoor and indoor unit.
- Rated cooling capacity obtained with air entering the indoor unit at 80°F dry bulb (DB) and 67°F wet bulb (WB) and outdoor ambient conditions of 95°F dry bulb (DB) and 75°F wet bulb (WB). Rated heating capacity obtained with air entering the indoor unit at 70°F dry bulb (DB) and 60°F wet bulb (WB) and outdoor ambient conditions of 47°F dry bulb (DB) and 43°F wet bulb (WB). For capacity information, see engineering manual capacity tables.
- All power/communication wiring minimum 4-conductor, stranded, shielded, and must comply with applicable local and national codes.
- Installation of an optional Low Ambient Wind Baffle Kit will allow operation down to 0°F in cooling mode for applicable outdoor units.
- Airflow shown is in cooling mode.
- Sound pressure levels are tested in an anechoic chamber under ISO Standard 3745 and are the same in both cooling and heating mode. These values can increase due to ambient conditions during operation.
- Piping lengths are equivalent.
- W-F is not available for LA240HSV3.
- Due to our commitment to continued innovation, some specifications may be changed without notification.

# ART COOL™ PREMIER with LGRED° heat

SINGLE ZONE



LGRED°



LA090HYV1  
LA120HYV1  
LA150HYV2  
LA180HYV2



Specification	Unit	LA090HYV1	LA120HYV1	LA150HYV2	LA180HYV2
Indoor Unit		LAN090HYV1	LAN120HYV1	LAN150HYV2	LAN180HYV2
Outdoor Unit		LAU090HYV1	LAU120HYV1	LAU150HYV2	LAU180HYV2
Rated Cooling Capacity	Btu/h	9,000	11,000	15,000	18,200
Cooling Capacity Range	Btu/h	1,023 - 12,966	1,023 - 13,785	3,070 - 21,000	3,070 - 29,515
Rated Heating Capacity	Btu/h	11,000	12,000	18,000	22,000
Heating Capacity Range	Btu/h	1,023 - 20,472	1,023 - 22,178	3,070 - 25,200	3,070 - 32,000
Max Heating Capacity at 17°F	Btu/h	11,940	14,650	21,430	27,400
Max Heating Capacity at 5°F	Btu/h	11,220	13,720	18,950	24,360
Max Heating Capacity at -13°F	Btu/h	7,920	9,520	14,660	19,120
SEER, EER		27.5, 15.65	25.5, 13.75	24.0, 13.48	22.0, 12.5
HSPF		12	12	12.5	12.0
Voltage (IDU)	V, Ø, Hz	208/230-1-60	208/230-1-60	208/230-1-60	208/230-1-60
Voltage (ODU)	V, Ø, Hz	208/230-1-60	208/230-1-60	208/230-1-60	208/230-1-60
Cooling Power Input	kW	0.58	0.8	1.11	1.46
Heating Power Input	kW	0.71	0.75	1.39	1.79
MCA, MOCP	A	11.2, 15	11.2, 15	19.0, 25	19.0, 25
Power/Communication Wiring <sup>f</sup>	No. x AWG	4 x 18	4 x 18	4 x 18	4 x 18
Rated Amps Cool/Heat	A	8.7/8.7	8.7/8.7	15.0/15.0	15.0/15.0
Heating Operation Range	*F WB	-13 - 65	-13 - 65	-13-65	-13-65
Cooling Operation Range	*F DB	14-118	14-118	14-118	14-118
Optional Wind Baffle <sup>g</sup>		ZLABGP01A (0°F)	ZLABGP01A (0°F)	ZLABGP02A (0°F)	ZLABGP02A (0°F)
IDU Operation Range Cooling	*F WB	53 - 75	53 - 75	53 - 75	53 - 75
IDU Operation Range Heating	*F DB	60 - 86	60 - 86	60 - 86	60 - 86
Setpoint Range Cooling	*F	64 - 86	64 - 86	64 - 86	64 - 86
Setpoint Range Heating	*F	60 - 86	60 - 86	60 - 86	60 - 86
IDU Dimensions (WxHxD)	in	34-7/16x11-5/8x9-1/4	34-7/16x11-5/8x9-1/4	42-15/16x12-31/32x9-25/32	42-15/16x12-31/32x9-25/32
ODU Dimensions (WxHxD)	in	30-5/16x21-1/2x11-5/16	30-5/16x21-1/2x11-5/16	34-1/4 x 31-1/2 x 12-19/32	34-1/4 x 31-1/2 x 12-19/32
IDU Weight (Net/Shipping)	lbs	24/30	24/30	34/38	34/38
ODU Weight (Net/Shipping)	lbs	77/82	77/82	122/131	122/131
Airflow (Max/H/M/L)	CFM	547/494/417/283	547/494/417/283	742/565/424/318	777/565/424/318
Dehumidification	pts/hr	3.20	3.60	3.80	4.60
Compressor Type		Twin Rotary	Twin Rotary	Twin Rotary	Twin Rotary
Refrigerant Type		R410A	R410A	R410A	R410A
Indoor (H/M/L/SL)	dB(A)	42/36/25/17	42/36/25/17	47/42/37/29	47/42/37/29
Outdoor Max	dB(A)	45	45	57	57
Liquid Pipe	in	1/4	1/4	3/8	3/8
Vapor Pipe	in	3/8	3/8	5/8	5/8
Pipe Length (Min/Max)	ft	6.6/65.6	6.6/65.6	9.8/98.4	9.8/98.4
Max Pipe Elevation	ft	32.8	32.8	65.6	65.6
Precharge Pipe Length	ft	41	41	24.6	24.6
Additional Refrigerant	oz/ft	0.22	0.22	0.38	0.38
Drain (OD, ID)	in	27/32, 5/8	27/32, 5/8	27/32, 5/8	27/32, 5/8
Controller	Supplied	AKB73835320	AKB73835320	AKB74955602	AKB74955602

Note:

- Rated capacity at 0 ft. above sea level with 25 ft. of refrigerant line and a 0 ft. level difference between outdoor and indoor unit.
- Rated cooling capacity obtained with air entering the indoor unit at 80°F dry bulb (DB) and 67°F wet bulb (WB) and outdoor ambient conditions of 95°F dry bulb (DB) and 75°F wet bulb (WB). Rated heating capacity obtained with air entering the indoor unit at 70°F dry bulb (DB) and 60°F wet bulb (WB) and outdoor ambient conditions of 47°F dry bulb (DB) and 43°F wet bulb (WB). For capacity information, see engineering manual capacity tables.
- All power/communication wiring minimum 4-conductor, stranded, shielded, and must comply with applicable local and national codes.
- Installation of an optional Low Ambient Wind Baffle Kit will allow operation down to 0°F in cooling mode for applicable outdoor units.
- Airflow shown is in cooling mode.
- Sound pressure levels are tested in an anechoic chamber under ISO Standard 3745 and are the same in both cooling and heating mode. These values can increase due to ambient conditions during operation.
- Pipe lengths are equivalent.
- Due to our commitment to continued innovation, some specifications may be changed without notification.

# ART COOL™ PREMIER

LA180HYV1  
LA240HYV1



Specification	Unit	LA180HYV1	LA240HYV1
	Indoor Unit	LAN180HYV1	LAN240HYV1
	Outdoor Unit	LAU180HYV1	LAU240HYV1
Capacity	Rated Cooling Capacity	Btu/h	22,000
	Cooling Capacity Range	Btu/h	3,070 - 29,515
	Rated Heating Capacity	Btu/h	22,000
	Heating Capacity Range	Btu/h	3,070 - 30,709
	Max Heating Capacity at 17°F	Btu/h	22,340
	Max Heating Capacity at 5°F	Btu/h	19,300
	Max Heating Capacity at -1.3°F	Btu/h	14,060
	SEER, EER		24, 13.48
	HSPF	13	12.3
Power	Voltage (IDU)	V, Ø, Hz	208-230, 1, 60
	Voltage (ODU)	V, Ø, Hz	208-230, 1, 60
	Cooling Power Input	kW	1.35
	Heating Power Input	kW	1.69
	MCA, MOCP	A	19, 25
	Power/Communication Wiring <sup>3</sup>	No. x AWG	4 x 18
	Rated Amps Cool/Heat	A	15.3/15.3
Operating Range	Heating Operation Range	°F WB	-13 - 65
	Cooling Operation Range	°F DB	14 - 118
	Optional Wind Baffle <sup>4</sup>		ZLABGPO2A (0°F)
	IDU Operation Range Cooling	°F WB	53 - 75
	IDU Operation Range Heating	°F DB	60 - 86
	Setpoint Range Cooling	°F	64 - 86
	Setpoint Range Heating	°F	60 - 86
Dimensions	IDU Dimensions (WxHxD)	in	42-15/16 x 12-31/32 x 9-25/32
	ODU Dimensions (WxHxD)	in	34-1/4 x 31-1/2 x 12-19/32
Weight	IDU Weight (Net/Shipping)	lbs	34/38
	ODU Weight (Net/Shipping)	lbs	122/131
Unit Data	Airflow (Max/H/M/L)	CFM	742/565/424/318
	Dehumidification	pts/hr	3.80
	Compressor Type		Twin Rotary
	Refrigerant Type		R-410A
Sound Pressure	Indoor (H/M/L/SL)	dB(A)	47/42/37/29
	Outdoor Max	dB(A)	57
Piping	Liquid Pipe	in	3/8
	Vapor Pipe	in	5/8
	Pipe Length (Min/Max)	ft	9.8/98.4
	Max Pipe Elevation	ft	65.6
	Precharge Pipe Length	ft	24.6
	Additional Refrigerant	oz/ft	0.38
	Drain (OD, ID)	in	27/32, 5/8
Controller	Supplied		AKB74835304

Note:

- Rated capacity at 0 ft. above sea level with 25 ft. of refrigerant line and a 0 ft. level difference between outdoor and indoor unit.
- Rated cooling capacity obtained with air entering the indoor unit at 80°F dry bulb (DB) and 67°F wet bulb (WB) and outdoor ambient conditions of 95°F dry bulb (DB) and 75°F wet bulb (WB). Rated heating capacity obtained with air entering the indoor unit at 70°F dry bulb (DB) and 60°F wet bulb (WB) and outdoor ambient conditions of 47°F dry bulb (DB) and 43°F wet bulb (WB). For capacity information, see engineering manual capacity tables.
- All power/communication wiring minimum 4-conductor; stranded, shielded, and must comply with applicable local and national codes.
- Installation of an optional Low Ambient Wind Baffle Kit will allow operation down to 0°F in cooling mode for applicable outdoor units.
- Airflow shown is in cooling mode.
- Sound pressure levels are tested in an anechoic chamber under ISO Standard 3745 and are the same in both cooling and heating mode. These values can increase due to ambient conditions during operation.
- Piping lengths are equivalent.
- Due to our commitment to continued innovation, some specifications may be changed without notification.



# EXTENDED PIPING



LS243HLV  
LS303HLV  
LS363HLV



Specification	Unit	LS243HLV	LS303HLV	LS363HLV
Indoor Unit		LSN243HLV	LSN303HLV	LSN363HLV
Outdoor Unit		LSU243HLV	LSU303HLV	LSU363HLV
Rated Cooling Capacity	Btu/h	22,000	30,000	33,000
Cooling Capacity Range	Btu/h	3,070 - 29,515	3,070 - 34,000	3,070 - 34,000
Rated Heating Capacity	Btu/h	27,000	32,000	35,200
Heating Capacity Range	Btu/h	3,070 - 38,898	3,070 - 38,898	3,070 - 38,898
Max Heating Capacity at 17°F	Btu/h	27,410	32,490	35,740
Max Heating Capacity at 5°F	Btu/h	23,690	28,080	30,890
Max Heating Capacity at -4°F	Btu/h	20,580	24,390	26,820
SEER, EER		21.5, 12.5	19.0, 10.0	17.5, 8.18
HSPF		11	10.0	10
Voltage (IDU)	V, Ø, Hz	208/230-1-60	208/230-1-60	208/230-1-60
Voltage (ODU)	V, Ø, Hz	208/230-1-60	208/230-1-60	208/230-1-60
Cooling Power Input	kW	1.76	3.00	4.04
Heating Power Input	kW	2.38	3.10	3.84
MCA, MOCP	A	19, 30	19, 30	19, 30
Recommended Fuse	A	25	25	25
Power/Communication Wiring <sup>3</sup>	No. x AWG	4 x 18	4 x 18	4 x 18
Rated Amps Cool/Heat	A	14.85/14.85	14.85/14.85	14.85/14.85
Heating Operation Range	*F WB	-4 - 65	-4 - 65	-4 - 65
Cooling Operation Range	*F DB	14 - 118	14 - 118	14 - 118
Optional Wind Baffle <sup>4</sup>		ZLABGP02A (0°F)	ZLABGP02A (0°F)	ZLABGP02A (0°F)
IDU Operation Range Cooling	*F WB	53 - 75	53 - 75	53 - 75
IDU Operation Range Heating	*F DB	60 - 86	60 - 86	60 - 86
Setpoint Range Cooling	*F	64 - 86	64 - 86	64 - 86
Setpoint Range Heating	*F	60 - 86	60 - 86	60 - 86
IDU Dimensions (WxHxD)	in	46-78x13-58x10-7/16	46-78x13-58x10-7/16	46-78x13-58x10-7/16
ODU Dimensions (WxHxD)	in	34-1/4x31-1/2x12-19/32	34-1/4x31-1/2x12-19/32	34-1/4x31-1/2x12-19/32
IDU Weight (Net/Shipping)	lbs	40/46	40/46	40/46
ODU Weight (Net/Shipping)	lbs	125/133	125/133	125/133
Airflow (Max/H/M/L) <sup>5</sup>	CFM	953/848/706/530	953/848/706/530	953/848/706/530
Dehumidification	pts/hr	5.5	5.9	6.6
Compressor Type		Twin Rotary	Twin Rotary	Twin Rotary
Refrigerant Type		R410A	R410A	R410A
Indoor (H/M/L/SL)	dB(A)	49/44/40/37	49/44/40/37	49/44/40/37
Outdoor Max	dB(A)	55	55	55
Liquid Pipe	in	3/8	3/8	3/8
Vapor Pipe	in	5/8	5/8	5/8
Pipe Length (Min/Max)	ft	9.84/164	9.84/164	9.84/164
Max Pipe Elevation	ft	98.4	98.4	98.4
Precharge Pipe Length	ft	24.6	24.6	24.6
Additional Refrigerant	oz/ft	0.38	0.38	0.38
Drain (OD, ID)	in	27/32, 5/8	27/32, 5/8	27/32, 5/8
Controller	Supplied	AKB74955602	AKB74955602	AKB74955602

#### Note:

- Rated capacity at 0 ft. above sea level with 25 ft. of refrigerant line and a 0 ft. level difference between outdoor and indoor unit.
- Rated cooling capacity obtained with air entering the indoor unit at 80°F dry bulb (DB) and 67°F wet bulb (WB) and outdoor ambient conditions of 95°F dry bulb (DB) and 75°F wet bulb (WB).  
Rated heating capacity obtained with air entering the indoor unit at 70°F dry bulb (DB) and 60°F wet bulb (WB) and outdoor ambient conditions of 47°F dry bulb (DB) and 43°F wet bulb (WB).  
For capacity information, see engineering manual capacity tables.
- All power/communication wiring minimum 4-conductor, stranded, shielded, and must comply with applicable local and national codes.
- Installation of an optional Low Ambient Wind Baffle Kit will allow operation down to 0°F in cooling mode for applicable outdoor units.
- Airflow shown is in cooling mode.
- Sound pressure levels are tested in an anechoic chamber under ISO Standard 3745 and are the same in both cooling and heating mode. These values can increase due to ambient conditions during operation.
- Pipe lengths are equivalent.
- Due to our commitment to continued innovation, some specifications may be changed without notification.

# HIGH EFFICIENCY



LS090HSV5  
LS120HSV5  
LS180HSV5



Specification	Unit	Most Efficient 2019			
		LS090HSV5	LS120HSV5	LS180HSV5	
Indoor Unit		LSN090HSV5	LSN120HSV5	LSN180HSV5	
Outdoor Unit		LSU090HSV5	LSU120HSV5	LSU180HSV5	
Capacity <sup>1,2</sup>	Rated Cooling Capacity	Btu/h	9,000	12,000	16,000
	Cooling Capacity Range	Btu/h	1,023 - 12,625	1,023 - 13,785	3,070 - 29,515
	Rated Heating Capacity	Btu/h	10,900	13,600	21,600
	Heating Capacity Range	Btu/h	1,023 - 17,061	1,023 - 22,178	3,070 - 38,898
	Max Heating Capacity at 17°F	Btu/h	11,080	13,810	22,340
	Max Heating Capacity at 5°F	Btu/h	9,570	11,930	19,300
	Max Heating Capacity at -4°F	Btu/h	8,310	10,360	16,760
	SEER, EER	Btu/h	23.5, 14.52	22.7, 12.5	21.5, 12.58
Power	HSPF		11.3	11.4	10.2
	Voltage (IDU)	V-Ø - Hz	208/230-1-60	208/230-1-60	208/230-1-60
	Voltage (ODU)	V-Ø - Hz	208/230-1-60	208/230-1-60	208/230-1-60
	Cooling Power Input	kW	0.62	0.96	1.43
	Heating Power Input	kW	0.71	1.04	1.73
	MCA, MOCP	A	10, 15	10, 15	13, 20
	Power/Communication Wiring <sup>3</sup>	No. x AWG	4 x 18	4 x 18	4 x 18
	Rated Amps (Cool/Heat)	A	7.4/7.4	7.4/7.4	9.85/9.85
Operation Range	Heating Operation Range	°F WB	-4 - 65	-4 - 65	-4 - 65
	Cooling Operation Range	°F DB	14 - 118	14 - 118	14 - 118
	Optional Wind Baffle <sup>4</sup>		ZLABGP01A (0°F)	ZLABGP01A (0°F)	ZLABGP02A (0°F)
	IDU Operation Range Cooling	°F	53 - 75	53 - 75	53 - 75
	IDU Operation Range Heating	°F	60 - 86	60 - 86	60 - 86
	Setpoint Range Heating	°F	60 - 86	60 - 86	60 - 86
Dimensions	IDU Dimensions (WxHxD)	in	32-15/16 x 12-1/8 x 7-7/16	32-15/16 x 12-1/8 x 7-7/16	39-9/32 x 13-19/32 x 8-9/32
	ODU Dimensions (WxHxD)	in	30-5/16 x 21-1/2 x 11-5/16	30-5/16 x 21-1/2 x 11-5/16	34-1/4 x 31-1/2 x 12-19/32
Weight	IDU Weight (Net/Shipping)	lbs	18.3 / 23.4	18.3 / 23.4	25.6 / 32.2
	ODU Weight (Net/Shipping)	lbs	74.1 / 78.9	74.1 / 78.9	116.8 / 126.5
Unit Data	Airflow (Max/H/M/L) <sup>5</sup>	CFM	459 / 338 / 317 / 194	459 / 338 / 317 / 194	706 / 530 / 477 / 371
	Dehumidification	pts/hr	2.7	2.7	5.5
	Compressor Type		Twin Rotary	Twin Rotary	Twin Rotary
	Refrigerant Type		R410A	R410A	R410A
Sound Pressure <sup>6</sup>	Indoor (H/M/L/SL)	dB(A)	39 / 33 / 23 / 19	39 / 33 / 23 / 19	45 / 40 / 35 / 29
	Outdoor Max	dB(A)	48	48	53
Piping <sup>7</sup>	Liquid Pipe	in	1/4	1/4	3/8
	Vapor Pipe	in	3/8	3/8	5/8
	Pipe Length (Min/Max)	ft	9.8 / 82	9.8 / 82	9.8 / 114.8
	Max Pipe Elevation	ft	49.2	49.2	49.2
	Precharge Pipe Length	ft	41	41	24.6
	Additional Refrigerant	oz/ft	0.22	0.22	0.38
Controller	Supplied		AKB74955602	AKB74955602	AKB74955602

**Note:**

- Rated capacity at 0 ft. above sea level with 25 ft. of refrigerant line and a 0 ft. level difference between outdoor and indoor unit.
- Rated cooling capacity obtained with air entering the indoor unit at 80°F dry bulb (DB) and 67°F wet bulb (WB) and outdoor ambient conditions of 95°F dry bulb (DB) and 75°F wet bulb (WB). Rated heating capacity obtained with air entering the indoor unit at 70°F dry bulb (DB) and 60°F wet bulb (WB) and outdoor ambient conditions of 47°F dry bulb (DB) and 43°F wet bulb (WB). For capacity information, see engineering manual capacity tables.
- All power/communication wiring minimum 4-conductor, stranded, shielded, and must comply with applicable local and national codes.
- Installation of an optional Low Ambient Wind Baffle Kit will allow operation down to 0°F in cooling mode for applicable outdoor units.
- Airflow shown is in cooling mode.
- Sound pressure levels are tested in an anechoic chamber under ISO Standard 3745 and are the same in both cooling and heating mode. These values can increase due to ambient conditions during operation.
- Piping lengths are equivalent.
- Due to our commitment to continued innovation, some specifications may be changed without notification.

# MEGA



LS090HEV1  
LS090HXV  
LS120HEV1  
LS120HXV  
LS180HEV1  
LS240HEV1



Specification	Unit	LS090HEV1	LS090HXV	LS120HEV1	LS120HXV	LS180HEV1	LS240HEV1
Indoor Unit		LSN090HEV1	LSN090HXV	LSN120HEV1	LSN120HXV	LSN180HEV1	LSN240HEV1
Outdoor Unit		LSU090HEV1	LSU090HXV	LSU120HEV1	LSU120HXV	LSU180HEV1	LSU240HEV1
Rated Cooling Capacity	Btu/h	8,500	8,500	12,000	12,000	17,000	22,000
Cooling Capacity Range	Btu/h	3,070 - 9,500	1,023 - 13,785	3,070 - 13,780	1,023 - 13,785	3,685 - 18,493	3,685 - 24,000
Rated Heating Capacity	Btu/h	9,000	10,900	12,000	13,000	19,000	22,000
Heating Capacity Range	Btu/h	3,070 - 10,500	1,023 - 22,178	3,070 - 13,780	1,023 - 22,178	3,685 - 22,997	3,685 - 24,226
Max Heating Capacity at 17°F	Btu/h	9,140	11,070	12,180	13,200	19,290	22,340
SEER, EER		19.0, 12.5	17.0, 12.01	17.0, 10.52	17.0, 10.5	18.0, 10.97	17.0, 10.76
HSPF		9.0	9.0	9.2	9.0	9.0	9.0
Voltage (IDU)	V, Ø, Hz	208/230-1-60	115-1-60	208/230-1-60	115-1-60	208/230-1-60	208/230-1-60
Voltage (ODU)	V, Ø, Hz	208/230-1-60	115-1-60	208/230-1-60	115-1-60	208/230-1-60	208/230-1-60
Cooling Power Input	kW	0.68	0.71	1.14	1.14	1.55	2.04
Heating Power Input	kW	0.78	0.88	0.98	1.09	1.59	1.94
MCA, MOCP	A	10.15	13.5, 20	10.15	13.5, 20	12.20	15.20
Power/Communication Wiring <sup>3</sup>	No. x AWG	4 x 18	4 x 18	4 x 18	4 x 18	4 x 18	4 x 18
Rated Amps Cool/Heat	A	7.5/7.5	10.4/10.4	7.5/7.5	10.4/10.4	9.6/9.41	11.52/11.08
Heating Operation Range	°F WB	14 - 65	14 - 65	14 - 65	14 - 65	14 - 65	14 - 65
Cooling Operation Range	°F DB	14 - 119	14 - 119	14 - 119	14 - 119	14 - 119	14 - 119
Optional Wind Baffle <sup>4</sup>		No	No	No	No	No	No
IDU Operation Range Cooling	°F WB	53 - 75	53 - 75	53 - 75	53 - 75	53 - 75	53 - 75
IDU Operation Range Heating	°F DB	60 - 86	60 - 86	60 - 86	60 - 86	60 - 86	60 - 86
Setpoint Range Cooling	°F	64 - 86	64 - 86	64 - 86	64 - 86	64 - 86	64 - 86
Setpoint Range Heating	°F	60 - 86	60 - 86	60 - 86	60 - 86	60 - 86	60 - 86
IDU Dimensions (WxHxD)	in	29-34x10-7/16x7-1/4	34-27/32x11-1/4x8-9/32	34-13/16x11-1/4x8-1/4	34-27/32x11-1/4x8-9/32	40-9/16x12-13/16x9-13/16	40-9/16x12-13/16x9-13/16
ODU Dimensions (WxHxD)	in	28-1/4x19-1/2x9-1/16	28-1/4x19-1/2x9-1/16	28-1/4x19-1/2x9-1/16	28-1/4x19-1/2x9-1/16	30-5/16x21-1/2x11-5/16	36-1/4x25-13/16x12-19/32
IDU Weight (Net/Shipping)	lbs	17/20	23/26	23/28	23/26	28/33	29/34
ODU Weight (Net/Shipping)	lbs	62/67	67/79	62/67	67/79	76/81	95/104
Airflow (Max/H/M/L)	CFM	318/276/226/177	335/272/212/124	424/353/272/212	335/272/212/124	629/512/441/353	689/600/494/388
Dehumidification	pes/hr	2.12	2.30	2.76	2.80	3.39	4.88
Compressor Type		Rotary	Rotary	Rotary	Rotary	Twin Rotary	Twin Rotary
Refrigerant Type		R410A	R410A	R410A	R410A	R410A	R410A
Indoor (H/W/L/SL)	dB(A)	39/33/25/19	39/33/23/19	39/33/25/19	39/33/23/19	42/40/35/29	45/40/35/29
Outdoor Max	dB(A)	47	47	47	47	51	53
Liquid Pipe	in	1/4	1/4	1/4	1/4	1/4	1/4
Vapor Pipe	in	3/8	3/8	3/8	3/8	1/2	5/8
Pipe Length (Min/Max)	ft.	9.8/49.2	6.6/49.2	9.8/49.2	6.6/49.2	9.8/65.6	9.8/65.6
Max Pipe Elevation	ft.	22.9	22.9	22.9	22.9	32.8	32.8
Precharge Pipe Length	ft.	24.6	24.6	24.6	24.6	24.6	24.6
Additional Refrigerant	oz/ft	0.22	0.22	0.22	0.22	0.33	0.33
Drain (OD, ID)	in	27/32, 5/8	27/32, 5/8	27/32, 5/8	27/32, 5/8	27/32, 5/8	27/32, 5/8
Controller	Supplied	AKB7383531B	AKB73456121	AKB7383531B	AKB73456121	AKB7383531B	AKB7383531B

#### Note

- Rated capacity at 0 ft. above sea level with 25 ft. of refrigerant line and a 0 ft. level difference between outdoor and indoor unit.
- Rated cooling capacity obtained with air entering the indoor unit at 80°F dry bulb (DB) and 67°F wet bulb (WB) and outdoor ambient conditions of 95°F dry bulb (DB) and 75°F wet bulb (WB). Rated heating capacity obtained with air entering the indoor unit at 70°F dry bulb (DB) and 60°F wet bulb (WB) and outdoor ambient conditions of 47°F dry bulb (DB) and 43°F wet bulb (WB). For capacity information, see engineering manual capacity tables.
- All power/communication wiring minimum 4-conductor, stranded, shielded, and must comply with applicable local and national codes.
- Airflow shown is in cooling mode.
- Sound pressure levels are tested in an anechoic chamber under ISO Standard 3745 and are the same in both cooling and heating mode. These values can increase due to ambient conditions during operation.
- Piping lengths are equivalent.
- Due to our commitment to continued innovation, some specifications may be changed without notification.



# CEILING MOUNTED



LC098HV4  
LC128HV4  
LC188HV4

LC187HV  
LC247HV  
LC367HV  
LC427HV



Specification	Unit	LC098HV4	LC128HV4	LC188HV4	LC187HV	LC247HV	LC367HV	LC427HV
Indoor Unit		LCN098HV4	LCN128HV4	LCN188HV4	LCN187HV	LCN247HV	LCN367HV	LCN427HV
Outdoor Unit		LUU097HV	LUU127HV	LUU189HV	LUU187HV	LUU247HV	LUU367HV	LUU427HV
Rated Cooling Capacity	Btu/h	9,000	11,100	18,000	18,000	24,000	36,000	42,000
Cooling Capacity Range	Btu/h	3,600 - 9,900	3,400 - 12,400	7,700 - 24,900	9,500 - 19,900	9,700 - 26,700	14,000 - 42,000	17,100 - 47,100
Rated Heating Capacity	Btu/h	11,000	14,000	18,500	20,000	27,000	40,000	47,000
Heating Capacity Range	Btu/h	4,400 - 12,100	2,800 - 15,500	6,500 - 23,400	9,300 - 22,000	10,900 - 30,000	14,500 - 45,000	17,100 - 52,600
Max Heating Capacity at 17°F	Btu/h	9,350	11,900	17,000	14,330	21,343	30,311	34,681
Max Heating Capacity at 5°F	Btu/h	8,250	10,500	15,000	11,271	20,778	29,250	33,351
SEER, EER		20.2, 13.65	19.4, 12.6	20.5, 12.5	20, 15.0	17.0, 12.6	19.0, 13.5	17.0, 10.3
HSPF		10.5	10.4	10	10.1	9.7	9.5	8.6
Voltage (IDU)	V, Ø, Hz	208-230, 1, 60	208-230, 1, 60	208/230-1-60	208/230-1-60	208/230-1-60	208/230-1-60	208/230-1-60
Voltage (ODU)	V, Ø, Hz	208-230, 1, 60	208-230, 1, 60	208/230-1-60	208/230-1-60	208/230-1-60	208/230-1-60	208/230-1-60
Cooling Power Input	kW	0.66	0.88	1.44	1.26	1.91	2.97	4.07
Heating Power Input	kW	0.83	1.19	1.95	1.50	2.60	3.20	4.05
MCA, MOCP	A	11.9, 15	12.3, 15	20, 30	18.1, 30	18.1, 30	24.5, 40	24.5, 40
Power/Communication Wiring <sup>1</sup>	No. x AWG	4 x 18	4 x 18	4 x 18	4 x 18	4 x 18	4 x 18	4 x 18
Rated Amps Cool/Heat	A	9.65/9.65	10.05/10.05	15.1/15.1	14.7/14.7	15.1/15.1	20.2/20.8	20.2/20.8
Heating Operation Range	°F WB	-4 - 64	-4 - 64	-4 - 64	0 - 64	0 - 64	0 - 64	0 - 64
Cooling Operation Range	°F DB	0 - 118	0 - 118	5 - 118	5 - 118	5 - 118	5 - 118	5 - 118
Optional Wind Baffle <sup>4</sup>		ZLABGP01A (-4°F)	ZLABGP01A (-4°F)	ZLABGP04A (0°F)	ZLABGP04A (0°F)	ZLABGP04A (0°F)	ZLABGP04A x 2 (0°F)	ZLABGP04A x 2 (0°F)
IDU Operation Range Cooling	°F WB	57 - 77	57 - 77	57 - 77	57 - 77	57 - 77	57 - 77	57 - 77
IDU Operation Range Heating	°F DB	59 - 81	59 - 81	59 - 81	59 - 81	59 - 81	59 - 81	59 - 81
Setpoint Range Cooling	°F	65 - 86	65 - 86	65 - 86	64 - 86	64 - 86	64 - 86	64 - 86
Setpoint Range Heating	°F	61 - 86	61 - 86	61 - 86	60 - 86	60 - 86	60 - 86	60 - 86
IDU Dimensions (WxHxD)	in	22-7/16 x 8-7/16 x 22-7/16	22-7/16 x 8-7/16 x 22-7/16	22-7/16 x 10-3/32 x 22-7/16	33-1/16 x 8-1/32 x 33-1/16	33-1/16 x 8-1/32 x 33-1/16	33-1/16 x 11-1/32 x 33-1/16	33-1/16 x 11-1/32 x 33-1/16
ODU Dimensions (WxHxD)	in	30-5/16 x 21-15/32 x 11-11/32	30-5/16 x 21-15/32 x 11-11/32	37-13/32 x 32-27/32 x 13	37-13/32 x 32-27/32 x 13	37-13/32 x 32-27/32 x 13	37-13/32 x 54-11/32 x 13	37-13/32 x 54-11/32 x 13
IDU Weight (Net/Shipping)	lbs	31/37	31/37	31.5 / 40.0	46 / 55	46 / 55	55 / 65	55 / 65
ODU Weight (Net/Shipping)	lbs	82/89	82/89	127.8 / 140.0	133 / 148	133 / 148	203 / 227	203 / 227
Airflow (H/M/L) <sup>2</sup>	CFM	300/265/230	335/283/247	460/424/388	565/494/424	600/530/459	1,060/989/918	1,060/989/918
Dehumidification	pts/hr	1.60	2.47	3.3	5.10	5.10	7.70	7.70
Compressor Type		Twin Rotary	Twin Rotary	Twin Rotary	Twin Rotary	Twin Rotary	Twin Rotary	Twin Rotary
Refrigerant Type		R410A	R410A	R410A	R410A	R410A	R410A	R410A
Indoor (H/M/L)	dB(A)	36/33/30	38/35/32	41/39/36	38/36/34	38/36/34	46/44/43	46/44/43
Outdoor Max	dB(A)	51	52	52	52	52	54	54
Liquid Pipe	in	1/4	1/4	3/8	3/8	3/8	3/8	3/8
Vapor Pipe	in	3/8	3/8	5/8	5/8	5/8	5/8	5/8
Pipe Length (Min/Max)	ft	9.8/66	9.8/66	6.6/164	6.6/164	6.6/164	6.6/246.1	6.6/246.1
Max Pipe Elevation	ft	49.2	49.2	98.4	98.4	98.4	98.4	98.4
Precharge Pipe Length	ft	24.6	24.6	24.6	24.6	24.6	24.6	24.6
Additional Refrigerant	oz/ft	0.22	0.22	0.43	0.43	0.43	0.43	0.43
Drain (OD, ID)	in	1.25, 1	1.25, 1	1.25/1	1.25/1	1.25/1	1.25/1	1.25/1
Controller	Supplied	PQWRHQ0FDB	PQWRHQ0FDB	PQWRHQ0FDB	PQWRHQ0FDB	PQWRHQ0FDB	PQWRHQ0FDB	PQWRHQ0FDB
Grille		PT-QC1W0/PT-UQC	PT-QC1W0/PT-UQC	PT-QC1W0/PT-UQC	PT-UMC1B/PT-UMC1	PT-UMC1B/PT-UMC1	PT-UMC1B/PT-UMC1	PT-UMC1B/PT-UMC1
Grille Weight (Net/Shipping)	lbs	7/9	7/9	7/9	11/20	11/20	11/20	11/20

Note:

- Rated capacity at 0 ft. above sea level with 25 ft. of refrigerant line and a 0 ft. level difference between outdoor and indoor unit.
- Rated cooling capacity obtained with air entering the indoor unit at 80°F dry bulb (DB) and 67°F wet bulb (WB) and outdoor ambient conditions of 95°F dry bulb (DB) and 75°F wet bulb (WB).  
Rated heating capacity obtained with air entering the indoor unit at 70°F dry bulb (DB) and 60°F wet bulb (WB) and outdoor ambient conditions of 47°F dry bulb (DB) and 43°F wet bulb (WB).  
For capacity information, see engineering manual capacity tables.
- All power/communication wiring minimum 4-conductor, stranded, shielded, and must comply with applicable local and national codes.
- Installation of an optional Low Ambient Wind Baffle Kit will allow operation down to 0°F in cooling mode for applicable outdoor units.
- Airflow shown is in cooling mode.
- Sound pressure levels are tested in an anechoic chamber under ISO Standard 3745 and are the same in both cooling and heating mode. These values can increase due to ambient conditions during operation.
- Piping lengths are equivalent.
- Due to our commitment to continued innovation, some specifications may be changed without notification.

# LOW STATIC DUCTED



LD097HV4  
LD127HV4  
LD187HV4



Specification	Unit	LD097HV4	LD127HV4	LD187HV4
Indoor Unit		LDN097HV4	LDN127HV4	LDN187HV4
Outdoor Unit		LUU097HV	LUU127HV	LUU189HV
Rated Cooling Capacity	Btu/h	9,000	11,600	18,000
Cooling Capacity Range	Btu/h	3,600 - 9,900	4,640 - 12,760	7,400 - 21,100
Rated Heating Capacity	Btu/h	14,000	16,000	20,000
Heating Capacity Range	Btu/h	5,600 - 15,400	6,400 - 17,600	6,800 - 21,800
Max Heating Capacity at 17°F	Btu/h	11,900	13,600	18,000
Max Heating Capacity at 5°F	Btu/h	10,500	12,000	16,000
SEER, EER		18.5, 12.7	19.6, 12.9	18, 11.5
HSPF		10.3	10.5	10
Voltage (IDU)	V, Ø, Hz	208-230, 1, 60	208-230, 1, 60	208-230, 1, 60
Voltage (ODU)	V, Ø, Hz	208-230, 1, 60	208-230, 1, 60	208-230, 1, 60
Cooling Power Input	kW	0.71	0.90	1.56
Heating Power Input	kW	1.43	1.29	2.0
MCA, MOCP	A	11.9, 15	12.3, 15	20, 30
Power/Communication Wiring <sup>4</sup>	No. x AWG	4 x 18	4 x 18	4 x 18
Rated Amps Cool/Heat	A	9.65/9.65	10.05/10.05	15.9/15.9
Heating Operation Range	°F WB	-4 - 64	-4 - 64	-4 - 64
Cooling Operation Range	°F DB	0 - 118	0 - 118	5 - 118
Optional Wind Baffle <sup>5</sup>		ZLABGP01A (-4°F)	ZLABGP01A (-4°F)	ZLABGP04A (-4°F)
IDU Operation Range Cooling	°F WB	57 - 77	57 - 77	57 - 77
IDU Operation Range Heating	°F DB	59 - 81	59 - 81	59 - 81
Setpoint Range Cooling	°F	65 - 86	65 - 86	65 - 86
Setpoint Range Heating	°F	61 - 86	61 - 86	61 - 86
IDU Dimensions (WxHxD)	in	27-9/16 x 7-15/32 x 27-9/16	35-7/16 x 7-15/32 x 27-9/16	35-7/16 x 7-15/32 x 27-9/16
ODU Dimensions (WxHxD)	in	30-5/16 x 21-15/32 x 11-11/32	30-5/16 x 21-15/32 x 11-11/32	37-13/32 x 32-27/32 x 13
IDU Weight (Net/Shipping)	lbs	39/46	51/60	49/58
ODU Weight (Net/Shipping)	lbs	82/89	82/89	126/140
Airflow (Max/H/M/L) <sup>7</sup>	CFM	318 / 247 / 194	353 / 300 / 247	530 / 441 / 353
Dehumidification	pts/hr	1.50	2.28	2.4
Compressor Type		Twin Rotary	Twin Rotary	Twin Rotary
Refrigerant Type		R-410A	R-410A	R-410A
Max External Static Pressure	in w.g.	0.20	0.20	0.20
Indoor (H/M/L)	dB(A)	30 / 26 / 23	31 / 28 / 27	36 / 34 / 31
Outdoor Max	dB(A)	51	52	52
Liquid Pipe	in	1/4	1/4	3/8
Vapor Pipe	in	3/8	3/8	5/8
Pipe Length (Min/Max)	ft	9.8/66	9.8/66	6.6/164
Max Pipe Elevation	ft	49.2	49.2	98.4
Precharge Pipe Length	ft	24.6	24.6	24.6
Additional Refrigerant	oz/ft	0.22	0.22	0.43
Drain (OD, ID)	in	1.25/1	1.25/1	1.25/1
Controller	Additional Accessory <sup>9</sup>	Wired Controller	Wired Controller	Wired Controller

**Note:**

- Rated capacity at 0 ft. above sea level with 25 ft. of refrigerant line and a 0 ft. level difference between outdoor and indoor unit.
- Rated cooling capacity obtained with air entering the indoor unit at 80°F dry bulb (DB) and 67°F wet bulb (WB) and outdoor ambient conditions of 95°F dry bulb (DB) and 75°F wet bulb (WB). Rated heating capacity obtained with air entering the indoor unit at 70°F dry bulb (DB) and 60°F wet bulb (WB) and outdoor ambient conditions of 47°F dry bulb (DB) and 43°F wet bulb (WB). For capacity information, see engineering manual capacity tables.
- Sound pressure levels are tested in an anechoic chamber under ISO Standard 3745 and are the same in both cooling and heating mode. These values can increase due to ambient conditions during operation.
- All power/communication wiring minimum 4-conductor, stranded, shielded, and must comply with applicable local and national codes.
- Piping lengths are equivalent.
- Installation of an optional Low Ambient Wind Baffle Kit will allow operation down to 0°F in cooling mode for applicable outdoor units.
- Airflow shown is in cooling mode.
- Due to our commitment to continued innovation, some specifications may be changed without notification.
- All LG wired controls are compatible and can be considered for control.

# HIGH STATIC DUCTED



LH247HV  
LH367HV



Specification	Unit	LH247HV	LH367HV
Indoor Unit		LHN247HV	LHN367HV
Outdoor Unit		LUU247HV	LUU367HV
Rated Cooling Capacity	Btu/h	24,000	36,000
Cooling Capacity Range	Btu/h	9,700 - 26,700	16,000 - 41,400
Rated Heating Capacity	Btu/h	27,000	40,000
Heating Capacity Range	Btu/h	10,900 - 30,000	17,500 - 48,000
Max Heating Capacity at 17°F	Btu/h	20,257	32,332
Max Heating Capacity at 5°F	Btu/h	19,556	31,200
SEER, EER		17.0, 12.0	17.6, 12.1
HSPF		10.0	9.2
Voltage (IDU)	V, Ø, Hz	208/230-1-60	208/230-1-60
Voltage (ODU)	V, Ø, Hz	208/230-1-60	208/230-1-60
Cooling Power Input	kW	2.00	2.91
Heating Power Input	kW	2.28	3.36
MCA, MOCP	A	18.1, 30	24.5, 40
Power/Communication Wiring <sup>4</sup>	No. x AWG	4 x 18	4 x 18
Rated Amps Cool/Heat	A	15.1/15.1	20.8/21.4
Heating Operation Range	°F WB	0 - 64	0 - 64
Cooling Operation Range	°F DB	5 - 118	5 - 118
Optional Wind Baffle <sup>5</sup>		ZLABGP04A (0°F)	ZLABGP04A x 2 (0°F)
IDU Operation Range Cooling	°F WB	57 - 77	57 - 77
IDU Operation Range Heating	°F DB	59 - 81	59 - 81
Setpoint Range Cooling	°F	64 - 86	64 - 86
Setpoint Range Heating	°F	60 - 86	60 - 86
IDU Dimensions (WxHxD)	in	46-17/32 x 11-23/32 x 17-23/32	48-7/16 x 14-31/32 x 23-7/32
ODU Dimensions (WxHxD)	in	37-13/32 x 32-27/32 x 13	37-13/32 x 54-11/32 x 13
IDU Weight (Net/Shipping)	lbs	73 / 95	125 / 139
ODU Weight (Net/Shipping)	lbs	133 / 146	203 / 227
Airflow (Max/H/M/L) <sup>7</sup>	CFM	688/618/530	1,130/953/706
Dehumidification	pts/hr	7.00	10.60
Compressor Type		Twin Rotary	Twin Rotary
Refrigerant Type		R410A	R410A
Max External Static Pressure	in w.g.	0.78	0.60
Indoor (H/M/L)	dB(A)	38/36/35	39/38/37
Outdoor Max	dB(A)	52	54
Liquid Pipe	in	3/8	3/8
Vapor Pipe	in	5/8	5/8
Pipe Length (Min/Max)	ft.	6.6/164	6.6/246.1
Max Pipe Elevation	ft.	98.4	98.4
Precharge Pipe Length	ft.	24.6	24.6
Additional Refrigerant	oz/ft	0.43	0.43
Drain (OD, ID)	in	1.25/1	1.25/1
Controller	Additional Accessory <sup>9</sup>	Wired Controller	Wired Controller

**Note:**

1. Rated capacity at 0 ft. above sea level with 25 ft. of refrigerant line and a 0 ft. level difference between outdoor and indoor unit.
2. Rated cooling capacity obtained with air entering the indoor unit at 80°F dry bulb (DB) and 67°F wet bulb (WB) and outdoor ambient conditions of 95°F dry bulb (DB) and 75°F wet bulb (WB). Rated heating capacity obtained with air entering the indoor unit at 70°F dry bulb (DB) and 60°F wet bulb (WB) and outdoor ambient conditions of 47°F dry bulb (DB) and 43°F wet bulb (WB). For capacity information, see engineering manual capacity tables.
3. Sound pressure levels are tested in an anechoic chamber under ISO Standard 3745 and are the same in both cooling and heating mode. These values can increase due to ambient conditions during operation.
4. All power/communication wiring minimum 4-conductor stranded, shielded, and must comply with applicable local and national codes.
5. Piping lengths are equivalent.
6. Installation of an optional Low Ambient Wind Baffle Kit will allow operation down to 0°F in cooling mode for applicable outdoor units.
7. Airflow shown is in cooling mode.
8. Due to our commitment to continued innovation, some specifications may be changed without notification.
9. All LG wired controls are compatible and can be considered for control.



# VERTICAL AHU



LV180HV4  
LV240HV4



LV360HV4  
LV420HV  
LV480HV





















Specification	Unit	LV180HV4	LV240HV4	LV360HV4	LV420HV	LV480HV	
Indoor Unit		LVN180HV4	LVN240HV4	LVN360HV4	LVN420HV	LVN480HV	
Outdoor Unit		LUU168HV	LUU248HV	LUU368HV	LUU428HV	LUU488HV	
Rated Cooling Capacity	Btu/h	18,000	24,000	36,000	42,000	48,000	
Cooling Capacity Range	Btu/h	8,000 - 24,000	9,000 - 28,000	14,000 - 44,000	17,000 - 48,000	18,000 - 53,000	
Rated Heating Capacity	Btu/h	20,000	27,000	40,000	47,000	56,000	
Heating Capacity Range	Btu/h	9,000 - 23,000	10,000 - 30,000	15,000 - 47,000	18,000 - 55,000	19,000 - 60,000	
Capacity <sup>1,2</sup>	Max Heating Capacity at 17°F	Btu/h	18,000	22,000	32,000	37,000	40,000
	Max Heating Capacity at 5°F	Btu/h	16,000	20,000	30,000	32,000	34,000
	Max Heating Capacity at -4°F	Btu/h	11,000	15,000	22,000	24,000	26,000
	SEER, EER		19, 13.33	18, 12.5	18, 12.5	17, 11.05	16.5, 10
	HSPF		9.5	10	10	10	9.5
Power	Voltage (IDU)	V, Ø, Hz	208/230-1-60	208/230-1-60	208/230-1-60	208/230-1-60	208/230-1-60
	Voltage (ODU)	V, Ø, Hz	208/230-1-60	208/230-1-60	208/230-1-60	208/230-1-60	208/230-1-60
	Cooling Power Input	KW	1.35	1.92	2.88	3.80	4.80
	Heating Power Input	KW	1.60	2.26	3.39	4.00	5.10
	MCA, MOC	A	20, 30	20, 30	32, 40	32, 40	32, 40
	Power/Communication Wiring <sup>3</sup>	No. x AWG	4 x 18	4 x 18	4 x 18	4 x 18	4 x 18
	Rated Amps Cool/Heat	A	15.1	15.1	24.2	24.2	24.2
Operating Range	Heating Operation Range	°F WB	-4 - 64	-4 - 64	-4 - 64	-4 - 64	-4 - 64
	Cooling Operation Range	°F DB	5 - 118	5 - 118	5 - 118	5 - 118	5 - 118
	Optional Wind Baffle <sup>4</sup>		ZLABGP04A (-4°F)	ZLABGP04A (-4°F)	ZLABGP04A x 2 (-4°F)	ZLABGP04A x 2 (-4°F)	ZLABGP04A x 2 (-4°F)
	IDU Operation Range Cooling	°F WB	57-77	57-77	57-77	57-77	57-77
	IDU Operation Range Heating	°F DB	59-81	59-81	59-81	59-81	59-81
	Setpoint Range Cooling	°F	65-86	65-86	65-86	65-86	65-86
	Setpoint Range Heating	°F	61-86	61-86	61-86	61-86	61-86
Dimensions	IDU Dimensions (WxHxD)	in	18 x 48-11/16 x 21-1/4	18 x 48-11/16 x 21-1/4	25 x 55-3/16 x 21-1/4	25 x 55-3/16 x 21-1/4	25 x 55-3/16 x 21-1/4
	ODU Dimensions (WxHxD)	in	37-13/32 x 32-27/32 x 13	37-13/32 x 32-27/32 x 13	37-13/32 x 54-11/32 x 13	37-13/32 x 54-11/32 x 13	37-13/32 x 54-11/32 x 13
Weight	IDU Weight (Net/Shipping)	lbs	129 / 140	129 / 140	165 / 188	165 / 188	165 / 188
	ODU Weight (Net/Shipping)	lbs	129 / 141	129 / 141	203 / 232	203 / 232	203 / 232
Unit Data	Airflow (Max/H/M/L) <sup>5</sup>	CFM	640 / 580 / 480	710 / 640 / 480	1,100 / 1,000 / 900	1,260 / 1,100 / 1,000	1,400 / 1,260 / 1,000
	Dehumidification	pts/hr	2	2.5	3.4	4.3	5.2
	Compressor Type		Twin Rotary	Twin Rotary	Twin Rotary	Twin Rotary	Twin Rotary
	Refrigerant Type		R410A	R410A	R410A	R410A	R410A
	Sound Pressure <sup>6</sup>	Indoor (H/M/L/SL)	dB(A)	42 / 42 / 41	43 / 42 / 41	45 / 44 / 43	46 / 45 / 44
Outdoor Max		dB(A)	52	52	54	54	54
Piping <sup>7</sup>	Liquid Pipe	in	3/8	3/8	3/8	3/8	3/8
	Vapor Pipe	in	5/8	5/8	5/8	5/8	5/8
	Pipe Length (Min/Max)	ft	6.6 / 164	6.6 / 164	6.6 / 246	6.6 / 246	6.6 / 246
	Max Pipe Elevation	ft	98.4	98.4	98.4	98.4	98.4
	Precharge Pipe Length	ft	24.6	24.6	24.6	24.6	24.6
	Additional Refrigerant	oz/ft	0.43	0.43	0.43	0.43	0.43
	Drain (OD, ID)	in	Primary & Secondary: 3/4 FPT	Primary & Secondary: 3/4 FPT	Primary & Secondary: 3/4 FPT	Primary & Secondary: 3/4 FPT	Primary & Secondary: 3/4 FPT
Controller	Additional Accessory <sup>8</sup>	Wired Controller	Wired Controller	Wired Controller	Wired Controller	Wired Controller	

#### Note:

- Rated capacity at 0 ft. above sea level with 25 ft. of refrigerant line and a 0 ft. level difference between outdoor and indoor unit.
- Rated cooling capacity obtained with air entering the indoor unit at 80°F dry bulb (DB) and 67°F wet bulb (WB) and outdoor ambient conditions of 95°F dry bulb (DB) and 75°F wet bulb (WB).
- Rated heating capacity obtained with air entering the indoor unit at 70°F dry bulb (DB) and 60°F wet bulb (WB) and outdoor ambient conditions of 47°F dry bulb (DB) and 43°F wet bulb (WB). For capacity information, see engineering manual capacity tables.
- All power/communication wiring minimum 4-conductor, stranded, shielded, and must comply with applicable local and national codes.
- Installation of an optional Low Ambient Wind Baffle Kit will allow operation down to -4°F in cooling mode for applicable outdoor units.
- Airflow shown is in cooling mode.
- Sound pressure levels are tested in an anechoic chamber under ISO Standard 3745 and are the same in both cooling and heating mode. These values can increase due to ambient conditions during operation.
- Piping lengths are equivalent.
- Due to our commitment to continued innovation, some specifications may be changed without notification.
- All LG wired controls are compatible and can be considered for control.























# MULTI-ZONE

## Lineup

OUTDOOR UNITS			
Btu/h	Multi F	Maximum Indoor Units	Combination Sample
18,000	 LMU18CHV   LMU180HHV	2	
24,000	 LMU24CHV   LMU240HHV	3	
30,000	 LMU30CHV   LMU300HHV	4	
36,000	 LMU36CHV	4	
kBtu	Multi F MAX	Maximum Indoor Units	
36,000	 LMU360HHV 	5	
42,000	 LMU420HHV 	6	
48,000	 LMU480HV	8	
54,000	 LMU540HV	8	
60,000	 LMU600HV	8	

# MULTI-ZONE

## Lineup

INDOOR UNITS							
Btu/h	7,000	9,000	12,000	15,000	18,000	24,000	36,000
Wall Mounted	ART COOL™ Gallery						
	ART COOL™ Mirror						
	High Efficiency						
Ceiling Mounted	4-Way Cassette						
Ducted	Low Static						
	High Static						
	Vertical AHU						 LMVN360HV



# MULTI F OUTDOOR UNITS

LMU18CHV  
LMU24CHV



LMU30CHV  
LMU36CHV



Specification	Unit	LMU18CHV	LMU24CHV	LMU30CHV	LMU36CHV	
Capacity	Rated Cooling Capacity	Btu/h	17,000	20,000	30,000	32,000
	Cooling Capacity Range	Btu/h	8,400 - 19,000	8,400 - 25,000	8,400 - 36,000	8,400 - 38,400
	Rated Heating Capacity	Btu/h	22,000	24,000	32,000	36,000
	Heating Capacity Range	Btu/h	10,248 - 24,000	9,240 - 28,800	9,240 - 38,400	9,240 - 41,600
	Max Heating Capacity at 17°F	Btu/h	19,161	21,097	26,739	29,105
	Max Heating Capacity at 5°F	Btu/h	14,807	14,595	20,622	22,057
	Max Heating Capacity at -4°F	Btu/h	9,912	10,385	13,753	15,823
	SEER, EER		22.0, 13.0	21.7, 13.5	22.0, 13.0	22.0, 13.0
Power	HSPF		9.7	10.6	10.0	10.0
	Voltage	V, Ø, Hz	208/230-1-60	208/230-1-60	208/230-1-60	208/230-1-60
	Cooling Power Input	kW	1.31	1.48	2.31	2.46
	Heating Power Input	kW	2.04	1.80	2.49	2.74
	MCA, MOCP	A	13.3, 20	14.3, 20	16.6, 25.0	17.9, 25
	Rated Amps (Cool/Heat)	A	11.09/11.09	11.99/11.99	13.93/13.93	15.13/15.13
	Power/Communication Wiring <sup>4</sup>	No. x AWG	4 x 18	4 x 18	4 x 18	4 x 18
Operating Range	Heating Operation Range	°F WB	-4 - 64	-4 - 64	-4 - 64	-4 - 64
	Cooling Operation Range	°F DB	14 - 118	14 - 118	14 - 118	14 - 118
	Optional Wind Baffle <sup>7</sup>		ZLABGP03A (-4°F)	ZLABGP03A (-4°F)	ZLABGP04A (-4°F)	ZLABGP04A (-4°F)
Dimensions & Weight	Dimensions (WxHxD)	in	34-1/4x25-25/32x12-19/32	34-1/4x25-25/32x12-19/32	37-13/32 x 32-27/32 x 13	37-13/32 x 32-27/32 x 13
	Weight (Net/Shipping)	lbs	100/108	100/108	137/148	137/148
Unit Data	Refrigerant Type		R410A	R410A	R410A	R410A
	Compressor Type		Twin Rotary	Twin Rotary	Twin Rotary	Twin Rotary
	Sound Pressure (Cooling / Heating)	dB(A)	49/52	49/52	52/55	52/55
	Maximum Air Volume	CFM	1,766	1,766	2,119	2,119
	Minimum Connectable IDUs	Qty	2	2	2	2
	Maximum Connectable IDUs	Qty	2	3	4	4
	Max Total IDU Connected Capacity	Btu/h	24,000	33,000	40,000	48,000
Piping	Liquid Pipe	in	1/4 x 2	1/4 x 3	1/4 x 4	1/4 x 4
	Vapor Pipe	in	3/8 x 2	3/8 x 3	3/8 x 4	3/8 x 4
	Maximum Total Pipe Length	ft	164	246.1	246.1	246.1
	Minimum Pipe Length per Segment	ft	9.8	9.8	9.8	9.8
	Maximum Pipe Length ODU to IDU	ft	82	82	82	82
	Precharge Pipe Length	ft	49.2	73.8	98.4	98.4
	Maximum Elevation ODU to IDU	ft	49.2	49.2	49.2	49.2
	Maximum Elevation IDU to IDU	ft	24.6	24.6	24.6	24.6
	Factory Charge of R410A	lbs	3.96	3.96	6.18	6.18
	Additional Refrigerant	oz/ft	0.22	0.22	0.22	0.22

Note:

1. Rated capacity at 0 ft. above sea level with 25 ft. of refrigerant line and a 0 ft. level difference between outdoor and indoor unit.
2. Rated cooling capacity obtained with air entering the indoor unit at 80°F dry bulb (DB) and 67°F wet bulb (WB) and outdoor ambient conditions of 95°F dry bulb (DB) and 75°F wet bulb (WB). Rated heating capacity obtained with air entering the indoor unit at 70°F dry bulb (DB) and 60°F wet bulb (WB) and outdoor ambient conditions of 47°F dry bulb (DB) and 43°F wet bulb (WB). For capacity information, see engineering manual capacity tables. Capacities are based on connection of Non-Ducted indoor units.
3. Sound pressure levels are tested in an anechoic chamber under ISO Standard 3745 and are the same in both cooling and heating mode. These values can increase due to ambient conditions during operation.
4. All power/communication wiring minimum 4-conductor, stranded, shielded, and must comply with applicable local and national codes.
5. Values when matched with non-ducted units only.
6. Piping lengths are equivalent.
7. Installation of an optional Low Ambient Wind Baffle Kit will allow operation down to -4°F in cooling mode for applicable outdoor units.
8. Due to our commitment to continued innovation, some specifications may be changed without notification.

# MULTI F OUTDOOR UNITS with LGRED<sup>®</sup> heat



LMU180HHV  
LMU240HHV

LGRED<sup>®</sup>



LMU300HHV

LGRED<sup>®</sup>

Multi-Zone

OUTDOOR UNITS

Model	Specification	Unit	LMU180HHV	LMU240HHV	LMU300HHV
Capacity <sup>1,2</sup>	Rated Cooling Capacity	Btu/h	18,000	24,000	28,400
	Cooling Capacity Range	Btu/h	8,400 - 19,980	8,400 - 30,000	8,400 - 34,080
	Rated Heating Capacity	Btu/h	22,000	26,000	28,600
	Heating Capacity Range	Btu/h	10,248 - 24,000	10,248 - 31,200	10,248 - 34,320
	Max Heating Capacity at 17°F	Btu/h	23,600	28,500	31,600
	Max Heating Capacity at 5°F	Btu/h	22,000	26,000	28,600
	Max Heating Capacity at -4°F	Btu/h	21,050	23,880	25,550
	Max Heating Capacity at -13°F	Btu/h	19,270	21,310	22,210
SEER, EER <sup>3</sup>			21, 13.5	21, 13.5	20, 12.5
HSPF <sup>3</sup>			10	10.7	11
Power	Voltage	V-Ø - Hz	208/230-1-60	208/230-1-60	208/230-1-60
	Cooling Power Input	kW	1.33	1.78	2.27
	Heating Power Input	kW	2.22	2.12	2.33
	MCA, MOCP <sup>4</sup>	A	186, 30	19, 30	19, 40
	Rated Amps	A	15.33	15.73	16.13
	Power/Communication Wiring <sup>5</sup>	No. x AWG	4 x 18	4 x 18	4 x 18
Operating Range	Heating Operation Range	°F WB	-13 - 64	-13 - 64	-13 - 64
	Cooling Operation Range	°F DB	14 - 118	14 - 118	14 - 118
	Optional Wind Baffle <sup>6</sup>		ZLABGP04A (-4°F)	ZLABGP04A (-4°F)	ZLABGP04A (-4°F)
Dimensions & Weight	Dimensions (WxHxD)	in	37-13/32 x 32-27/32 x 13	37-13/32 x 32-27/32 x 13	37-13/32 x 32-27/32 x 13
	Weight (Net/Shipping)	lbs	147.7/163.1	152.1/165.3	152.1/165.3
Unit Data	Refrigerant Type		R410A	R410A	R410A
	Compressor Type		Twin Rotary	Twin Rotary	Twin Rotary
	Sound Pressure (Cooling / Heating) <sup>7</sup>	dB(A)	50, 54	52, 55	52, 55
	Maximum Air Volume	CFM	2,295	2,295	2,295
	Minimum Connectable IDUs	Qty	2	2	2
	Maximum Connectable IDUs	Qty	2	3	4
	Max Total IDU Connected Capacity	Btu/h	24,000	33,000	40,000
Piping	Liquid Pipe	in	1/4 x 2	1/4 x 3	1/4 x 4
	Vapor Pipe	in	3/8 x 2	3/8 x 3	3/8 x 4
	Maximum Total Pipe Length	ft	164	246.1	246.1
	Minimum Pipe Length per Segment	ft	9.8	9.8	9.8
	Maximum Pipe Length ODU TO IDU	ft	82	82	82
	Precharge Pipe Length	ft	49.2	73.8	98.4
	Maximum Elevation ODU to IDU	ft	49.2	49.2	49.2
	Maximum Elevation IDU to IDU	ft	246	246	246
	Factory Charge of R410A	lbs	6.18	7.05	7.05
	Additional Refrigerant	oz/ft	0.22	0.22	0.22

Note:

- Rated capacity at 0 ft. above sea level with 25 ft. of refrigerant line and a 0 ft. level difference between outdoor and indoor unit.
- Rated cooling capacity obtained with air entering the indoor unit at 80°F dry bulb (DB) and 67°F wet bulb (WB) and outdoor ambient conditions of 95°F dry bulb (DB) and 75°F wet bulb (WB). Rated heating capacity obtained with air entering the indoor unit at 70°F dry bulb (DB) and 60°F wet bulb (WB) and outdoor ambient conditions of 47°F dry bulb (DB) and 43°F wet bulb (WB). For capacity information, see engineering manual capacity tables. Capacities are based on connection of Non-Ducted indoor units.
- Values when matched with non-ducted units only.
- Recommended fuse size is 25 Amps.
- All power/communication wiring minimum 4-conductor, stranded, shielded, and must comply with applicable local and national codes.
- Installation of an optional Low Ambient Wind Baffle Kit will allow operation down to -4°F in cooling mode for applicable outdoor units.
- Sound pressure levels are tested in an anechoic chamber under ISO Standard 3745 and are the same in both cooling and heating mode. These values can increase due to ambient conditions during operation.
- Piping lengths are equivalent.
- Due to our commitment to continued innovation, some specifications may be changed without notification.

# MULTI F MAX OUTDOOR UNITS



LMU480HV  
LMU540HV  
LMU600HV

Specification	Unit	LMU480HV	LMU540HV	LMU600HV	
Capacity	Rated Cooling Capacity	Btu/h	48,000	52,500	60,000
	Cooling Capacity Range	Btu/h	14,400 - 58,000	14,400 - 63,200	15,600 - 68,000
	Rated Heating Capacity	Btu/h	54,000	58,000	64,000
	Heating Capacity Range	Btu/h	15,840 - 61,000	16,272 - 64,000	17,940 - 70,000
	Max Heating Capacity at 17°F	Btu/h	49,014	51,832	53,560
	Max Heating Capacity at 5°F	Btu/h	38,900	41,137	42,720
	Max Heating Capacity at -4°F	Btu/h	27,529	29,112	33,193
	SEER, EER <sup>1</sup>		19.5, 12.5	18.4, 10.3	20.5, 11.4
HSPF <sup>2</sup>		10.0	8.7	11	
Power	Voltage	V, Ø, Hz	208/230-1-60	208/230-1-60	208/230-1-60
	Cooling Power Input	kW	3.84	5.1	5.26
	Heating Power Input	kW	4.32	5.4	5.33
	MCA, MOCP	A	27.3, 40	29.4, 40	32.2, 45
	Rated Amps (Cool/Heat)	A	22.96/22.96	24.76/24.76	27.06/27.06
	Power/Communication Wiring <sup>4</sup>	No. x AWG	ODU → BDU 4 x 16 BDU → IDU 4 x 18	ODU → BDU 4 x 16 BDU → IDU 4 x 18	ODU → BDU 4 x 16 BDU → IDU 4 x 18
Operating Range	Heating Operation Range	°F WB	-4 - 64	-4 - 64	-4 - 64
	Cooling Operation Range	°F DB	14 - 118	14 - 118	14 - 118
	Optional Wind Baffle <sup>7</sup>		ZLABGP04A x 2 (-4°F)	ZLABGP04A x 2 (-4°F)	ZLABGP04A x 2 (-4°F)
Dimensions & Weight	Dimensions (WxDxH)	in	37-13/32 x 54-11/32 x 13	37-13/32 x 54-11/32 x 13	37-13/32 x 54-11/32 x 13
	Weight (Net/Shipping)	lbs	214/236	214/236	223/249
Unit Data	Refrigerant Type		R410A	R410A	R-410A
	Compressor Type		Twin Rotary	Twin Rotary	Twin Rotary
	Sound Pressure (Cooling / Heating)	dB(A)	54/56	54/56	56/58
	Maximum Air Volume	CFM	2,119 x 2	2,119 x 2	2,119 x 2
	Minimum Connectable IDUs	Qty	2	2	2
	Maximum Connectable IDUs	Qty	8	8	8
	Max Total IDU Connected Capacity	Btu/h	65,000	73,800	81,000
Piping	Liquid Pipe	in	3/8	3/8	3/8
	Vapor Pipe	in	3/4	3/4	3/4
	Maximum Total Pipe Length	ft	475.7	475.7	475.7
	Minimum Pipe Length per Segment	ft	9.8	9.8	9.80
	Maximum Pipe Length ODU to IDU	ft	229.6	229.6	229.6
	Maximum Main Pipe Length	ft	180.4	180.4	180.4
	Precharge Pipe Length	ft	Main: 16.4 Branch: 131.2	Main: 16.4 Branch: 131.2	Main: 16.4 Branch: 131.2
	Maximum Elevation ODU to IDU	ft	98.4	98.4	98.4
	Maximum Elevation IDU to IDU	ft	49.2	49.2	49.2
	Maximum Elevation BDU to IDU	ft	32.8	32.8	38.2
	Maximum Elevation BDU to BDU	ft	49.2	49.2	49.2
	Factory Charge of R410A	lbs	9.7	9.7	12.3
	Additional Refrigerant	oz/ft	Main: 0.54 Branch: 0.22	Main: 0.54 Branch: 0.22	Main: 0.54 Branch: 0.22

Note:

1. Rated capacity at 0 ft. above sea level with 25 ft. of refrigerant line and a 0 ft. level difference between outdoor and indoor unit.
2. Rated cooling capacity obtained with air entering the indoor unit at 80°F dry bulb (DB) and 67°F wet bulb (WB) and outdoor ambient conditions of 95°F dry bulb (DB) and 75°F wet bulb (WB). Rated heating capacity obtained with air entering the indoor unit at 70°F dry bulb (DB) and 60°F wet bulb (WB) and outdoor ambient conditions of 47°F dry bulb (DB) and 43°F wet bulb (WB). For capacity information, see engineering manual capacity tables. Capacities are based on connection of Non-Ducted indoor units.
3. Sound pressure levels are tested in an anechoic chamber under ISO Standard 3745 and are the same in both cooling and heating mode. These values can increase due to ambient conditions during operation.
4. All power/communication wiring minimum 4-conductor, stranded, shielded, and must comply with applicable local and national codes.
5. Values when matched with non-ducted units only.
6. Piping lengths are equivalent.
7. Installation of an optional Low Ambient Wind Baffle Kit will allow operation down to -4°F in cooling mode for applicable outdoor units.
8. Due to our commitment to continual innovation, some specifications may be changed without notification.



# MULTI F MAX OUTDOOR UNITS with LGRED° heat



LMU360HHV  
LMU420HHV

LGRED°

Multi-Zone

OUTDOOR UNITS

Specification	Unit	LMU360HHV	LMU420HHV	
Capacity	Rated Cooling Capacity	Btu/h	36,000	42,000
	Cooling Capacity Range	Btu/h	11,700 - 46,733	11,700 - 53,897
	Rated Heating Capacity	Btu/h	41,000	45,000
	Heating Capacity Range	Btu/h	13,455 - 50,200	13,455 - 55,256
	Max Heating Capacity at 17°F	Btu/h	45,510	49,950
	Max Heating Capacity at 5°F	Btu/h	41,000	45,000
	Max Heating Capacity at -4°F	Btu/h	36,900	39,150
	Max Heating Capacity at -13°F	Btu/h	32,390	34,200
	SEER, EER <sup>1</sup>		21, 15	20.5, 14
HSPF <sup>2</sup>		11.5	11	
Power	Voltage	V-Ø-Hz	208/230-1-60	208/230-1-60
	Cooling Power Input	kW	2.4	3
	Heating Power Input	kW	2.93	3.3
	MCA, MOCP <sup>4</sup>	A	30.2, 45	30.2, 45
	Rated Amps	A	25.06	25.06
	Power/Communication Wiring <sup>5</sup>	A	ODU → BDU: 4 x 16 BDU → IDU: 4 x 18	ODU → BDU: 4 x 16 BDU → IDU: 4 x 18
	Operating Range	Heating Operation Range	°F WB	-13 - 64
Cooling Operation Range		°F DB	14 - 118	14 - 118
Optional Wind Baffle <sup>6</sup>			ZLABSP04A x2 (-4°F)	ZLABSP04A x2 (-4°F)
Dimensions & Weight	Dimensions (WxHxD)	in	37-13/32 x 54-11/32 x 13	37-13/32 x 54-11/32 x 13
	Weight (Net/Shipping)	lbs	222.7/249.1	222.7/249.1
Unit Data	Refrigerant Type		R410A	R410A
	Compressor Type		Twin Rotary	Twin Rotary
	Sound Pressure (Cooling / Heating) <sup>7</sup>	dB(A)	54 / 57	54 / 57
	Maximum Air Volume	CFM	2,119 x 2	2,119 x 2
	Minimum Connectable IDUs	Qty	2	2
	Maximum Connectable IDUs	Qty	5	6
	Max Total IDU Connected Capacity	Btu/h	48,000	56,000
	Piping	Liquid Pipe	in	3/8
Vapor Pipe		in	3/4	3/4
Maximum Total Pipe Length		ft	475.7	475.7
Minimum Pipe Length per Segment		ft	9.8	9.8
Maximum Pipe Length ODU to IDU		ft	229.6	229.6
Maximum Main Pipe Length (ODU to BDU)		ft	180.4	180.4
Maximum Branch Piping		ft	295.3	295.3
Maximum Pipe Length BDU to IDU		ft	49.2	49.2
Precharge Pipe Length		ft	Main: 16.4 Branch: 131.2	Main: 16.4 Branch: 131.2
Maximum Elevation ODU to IDU		ft	98.4	98.4
Maximum Elevation IDU to IDU		ft	49.2	49.2
Maximum Elevation BDU to IDU		ft	32.8	32.8
Maximum Elevation BDU to BDU		ft	49.2	49.2
Factory Charge of R410A		lbs	12.3	12.3
Additional Refrigerant		oz/ft	Main: 0.54 Branch: 0.22	Main: 0.54 Branch: 0.22

Note:

- Rated capacity at 0 ft. above sea level with 25 ft. of refrigerant line and a 0 ft. level difference between outdoor and indoor unit.
- Rated cooling capacity obtained with air entering the indoor unit at 80°F dry bulb (DB) and 67°F wet bulb (WB) and outdoor ambient conditions of 95°F dry bulb (DB) and 75°F wet bulb (WB). Rated heating capacity obtained with air entering the indoor unit at 70°F dry bulb (DB) and 60°F wet bulb (WB) and outdoor ambient conditions of 47°F dry bulb (DB) and 43°F wet bulb (WB). For capacity information, see engineering manual capacity tables. Capacities are based on connection of Non-Ducted indoor units.
- Values when matched with non-ducted units only.
- Recommended fuse size is 25 Amps.
- All power/communication wiring minimum 4-conductor, stranded, shielded, and must comply with applicable local and national codes.
- Installation of an optional Low Ambient Wind Baffle Kit will allow operation down to -4°F in cooling mode for applicable outdoor units.
- Sound pressure levels are tested in an anechoic chamber under ISO Standard 3745 and are the same in both cooling and heating mode. These values can increase due to ambient conditions during operation.
- Piping lengths are equivalent.
- Due to our commitment to continued innovation, some specifications may be changed without notification.

# MULTI F INDOOR UNITS



## ART COOL™ Gallery

Specification	Unit	LMAN097H-WP	LMAN127H-WP	
Capacity	Cooling	Btu/h	9,000	11,200
	Heating	Btu/h	10,400	13,300
Power	Voltage	V, Ø, Hz	208/230-1-60	208/230-1-60
	Power/Communication Wiring <sup>4</sup>	No. x AWG	4 x 18	4 x 18
Operating Range	Cooling	°F WB	57 - 77	57 - 77
	Heating	°F DB	59 - 81	59 - 81
Fan	Type		Turbo	Turbo
	Motor Output x Qty	W	24 x 1	24 x 1
	Motor/Drive		BLDC	BLDC
	Airflow (H/M/L)	CFM	272/208/155	314/258/198
	Rated Amps	A	0.2	0.2
Unit Data	Sound Pressure Level (H/M/L) <sup>3</sup>	dB(A)	39/35/31	42/38/34
	Dimensions (WxHxD)	in	23-5/8 x 23-5/8 x 5-25/32	23-5/8 x 23-5/8 x 5-25/32
	Weight (Net/Shipping)	lbs	32/37	32/37
	Liquid Pipe	in	1/4	1/4
Piping	Vapor Pipe	in	3/8	3/8
	Drain (OD, ID)	in	27/32, 5/8	27/32, 5/8
	Controller	Supplied	AKB73635607	AKB73635607

## Digital Airflow Control

The airflow can be controlled to ensure maximum comfort and convenience.

Normal



Jet Cool



Sleep Mode



## Customizable Picture Frame

With LG's revolutionary Art Cool Gallery, you can change the look of your air conditioner to whatever you want, whenever you want.



Note:

1. Rated capacity at 0 ft. above sea level with 25 ft. of refrigerant line and a 0 ft. level difference between outdoor and indoor unit.
2. Rated cooling capacity obtained with air entering the indoor unit at 80 °F dry bulb (DB) and 67 °F wet bulb (WB) and outdoor ambient conditions of 95 °F dry bulb (DB) and 75 °F wet bulb (WB). Rated heating capacity obtained with air entering the indoor unit at 70 °F dry bulb (DB) and 60 °F wet bulb (WB) and outdoor ambient conditions of 47 °F dry bulb (DB) and 43 °F wet bulb (WB).
3. Sound pressure levels are tested in an anechoic chamber under ISO Standard 3745 and are the same in both cooling and heating mode. These values can increase due to ambient conditions during operation.
4. All power/communication wiring minimum 4-conductor, stranded, shielded, and must comply with applicable local and national codes.
5. Due to our commitment to continued innovation, some specifications may be changed without notification.

# MULTI F INDOOR UNITS



## ART COOL™ Mirror



Specification	Unit	LAN090HSVS	LAN120HSVS	LAN180HSVS	
Capacity	Cooling	Btu/h	9,000	12,000	18,000
	Heating	Btu/h	10,900	13,600	21,600
Power	Voltage	V, Ø, Hz	208/230-1-60	208/230-1-60	208/230-1-60
	Power/Communication Wiring <sup>4</sup>	No. x AWG	4 x 18	4 x 18	4 x 18
Operating Range	Cooling	°F WB	57 - 77	57 - 77	57 - 77
	Heating	°F DB	59 - 81	59 - 81	59 - 81
Fan	Type		Cross Flow	Cross Flow	Cross Flow
	Motor Output x Qty	W	30 x 1	30 x 1	60 x 1
	Motor/Drive		BLDC	BLDC	BLDC
	Airflow (H/M/L)	CFM	268/218/169	282/233/177	558/438/353
Unit Data	Rated Amps	A	0.4	0.4	0.4
	Sound Pressure Level (H/M/L) <sup>3</sup>	dB(A)	36/32/27	38/34/29	44/38/34
	Dimensions (WxHxD)	in	32-15/16 x 12-1/8 x 7-9/16	32-15/16 x 12-1/8 x 7-9/16	39-9/32 x 13-19/32 x 8-11/32
	Weight (Net/Shipping)	lbs	20.5/25.6	20.5/25.6	29.8/36.4
Piping	Liquid Pipe	in	1/4	1/4	1/4
	Vapor Pipe	in	3/8	3/8	1/2
	Drain (OD/ID)	in	27/32, 5/8	27/32, 5/8	27/32, 5/8
Controller	Supplied		AKB74955602	AKB74955602	AKB74955602



## High Efficiency



Specification	Unit	LMN079HVT	LSN090HSVS	LSN120HSVS	LSN155HVT	LSN180HSVS	LMN249HVT	
Capacity	Cooling	Btu/h	7,000	9,000	12,000	14,300	18,000	24,000
	Heating	Btu/h	8,100	10,900	13,600	15,600	21,600	25,600
Power	Voltage	V, Ø, Hz	208/230-1-60	208/230-1-60	208/230-1-60	208/230-1-60	208/230-1-60	208/230-1-60
	Power/Communication Wiring <sup>4</sup>	No. x AWG	4 x 18	4 x 18	4 x 18	4 x 18	4 x 18	4 x 18
Operating Range	Cooling	°F WB	57 - 77	57 - 77	57 - 77	57 - 77	57 - 77	57 - 77
	Heating	°F DB	59 - 81	59 - 81	59 - 81	59 - 81	59 - 81	59 - 81
Fan	Type		Cross Flow	Cross Flow	Cross Flow	Cross Flow	Cross Flow	Cross Flow
	Motor Output x Qty	W	30 x 1	30 x 1	30 x 1	30 x 1	60 x 1	60 x 1
	Motor/Drive		BLDC	BLDC	BLDC	BLDC	BLDC	BLDC
	Airflow (H/M/L)	CFM	254/204/148	268/218/169	282/233/177	314/268/184	558/438/353	597/452/367
Unit Data	Rated Amps	A	0.4	0.4	0.4	0.4	0.4	0.4
	Sound Pressure Level (H/M/L) <sup>3</sup>	dB(A)	35/31/26	36/32/27	38/34/29	42/38/32	44/38/34	46/41/36
	Dimensions (WxHxD)	in	32-15/16 x 12-1/8 x 7-7/16	32-15/16 x 12-1/8 x 7-7/16	32-15/16 x 12-1/8 x 7-7/16	32-15/16 x 12-1/8 x 7-7/16	39-9/32 x 13-19/32 x 8-9/32	39-9/32 x 13-19/32 x 8-9/32
	Weight (Net/Shipping)	lbs	18.3 / 23.4	18.3 / 23.4	18.3 / 23.4	18.3 / 23.4	25.6 / 32.2	25.6 / 32.2
Piping	Liquid Pipe	in	1/4	1/4	1/4	1/4	1/4	1/4
	Vapor Pipe	in	3/8	3/8	3/8	3/8	1/2	1/2
	Drain (OD, ID)	in	27/32, 5/8	27/32, 5/8	27/32, 5/8	27/32, 5/8	27/32, 5/8	27/32, 5/8
Controller	Supplied		AKB74955602	AKB74955602	AKB74955602	AKB74955602	AKB74955602	

Note:

1. Rated capacity at 0 ft. above sea level with 25 ft. of refrigerant line and a 0 ft. level difference between outdoor and indoor unit.
2. Rated cooling capacity obtained with air entering the indoor unit at 80°F dry bulb (DB) and 67°F wet bulb (WB) and outdoor ambient conditions of 95°F dry bulb (DB) and 75°F wet bulb (WB).
3. Rated heating capacity obtained with air entering the indoor unit at 70°F dry bulb (DB) and 60°F wet bulb (WB) and outdoor ambient conditions of 47°F dry bulb (DB) and 43°F wet bulb (WB).
4. All power/communication wiring minimum 4-conductor, stranded, shielded, and must comply with applicable local and national codes.
5. Due to our commitment to continued innovation, some specifications may be changed without notification.



# MULTI F INDOOR UNITS

## 4-Way Cassette



Specification		Unit	LMD07BHV	LCN09B-IV4	LCN12BHV4	LCN18BHV4
Capacity	Cooling	Btu/h	7,000	9,000	12,000	18,000
	Heating	Btu/h	8,100	10,400	13,800	20,800
Power	Voltage	V, Ø, Hz	208/230-1-60	208/230-1-60	208/230-1-60	208/230-1-60
	Power/Communication Wiring <sup>4</sup>	No. x AWG	4 x 18	4 x 18	4 x 18	4 x 18
Operating Range	Cooling	*F WB	57 - 77	57 - 77	57 - 77	57 - 77
	Heating	*F DB	59 - 81	59 - 81	59 - 81	59 - 81
Fan	Type		Turbo	Turbo	Turbo	Turbo
	Motor Output x Qty	W	43 x 1	43 x 1	43 x 1	43 x 1
	Motor/Drive		BLDC	BLDC	BLDC	BLDC
	Airflow (H/M/L)	CFM	265/212/177	300/265/230	335/283/247	459/424/388
	Rated Amps	A	0.25	0.25	0.25	0.25
Unit Data	Sound Pressure Level (H/M/L) <sup>3</sup>	dB(A)	31/27/24	36/33/30	38/35/32	41/39/36
	Dimensions (WxHxD)	in	22-7/16 x 8-7/16 x 22-7/16	22-7/16 x 8-7/16 x 22-7/16	22-7/16 x 8-7/16 x 22-7/16	22-7/16 x 10-3/32 x 22-7/16
	Weight (Net/Shipping)	lbs	26/31	29/34	29/34	32/39
Piping	Liquid Pipe	in	1/4	1/4	1/4	1/4
	Vapor Pipe	in	3/8	3/8	3/8	1/2
	Drain (OD/ID)	in	1-1/4, 1	1-1/4, 1	1-1/4, 1	1-1/4, 1
Controller	Supplied <sup>5</sup>		AKB73757604	AKB73757604	AKB73757604	AKB73757604
	Model		PT-QCHW0/PT-UQC	PT-QCHW0/PT-UQC	PT-QCHW0/PT-UQC	PT-QCHW0/PT-UQC
Grille (Sold Separately)	Dimensions (WxHxD)	in	27-9/16 x 7/8 x 27-9/16	27-9/16 x 7/8 x 27-9/16	27-9/16 x 7/8 x 27-9/16	27-9/16 x 7/8 x 27-9/16
	Weight (Net/Shipping)	lbs	7/11	7/9	7/9	7/11

## Low Static Ducted



Specification		Unit	LDN09HV4	LDN12HV4	LDN18HV4
Capacity	Cooling	Btu/h	9,000	12,000	18,000
	Heating	Btu/h	10,400	13,800	20,800
Power	Voltage	V, Ø, Hz	208/230-1-60	208/230-1-61	208/230-1-62
	Power/Communication Wiring <sup>4</sup>	No. x AWG	4 x 18	4 x 18	4 x 18
Operating Range	Cooling	*F WB	57 - 77	57 - 77	57 - 77
	Heating	*F DB	59 - 81	59 - 81	59 - 81
Fan	Type		Sirocco	Sirocco	Sirocco
	Motor Output x Qty	W	19 x 1	5 x 1, 19 x 1	5 x 1, 19 x 1
	Motor/Drive		BLDC	BLDC	BLDC
	Airflow (H/M/L)	CFM	318/247/194	353/300/247	530/441/353
	Rated Amps	A	0.4	0.8	0.8
Unit Data	Factory Set External Static Pressure	in. wg	0.1	0.1	0.1
	Max. External Static Pressure	in. wg	0.2	0.2	0.2
	Sound Pressure Level (H/M/L) <sup>3</sup>	dB(A)	30/26/23	31/28/27	36/34/31
	Dimensions (WxHxD)	in	27-9/16 x 7-15/32 x 27-9/16	35-7/16 x 7-15/32 x 27-9/16	35-7/16 x 7-15/32 x 27-9/16
	Weight (Net/Shipping)	lbs	39/46	51/60	51/57
Piping	Liquid Pipe	in	1/4	1/4	1/4
	Vapor Pipe	in	3/8	3/8	1/2
	Drain (OD/ID)	in	1-1/4, 1	1-1/4, 1	1-1/4, 1
Controller	Additional Accessory <sup>5</sup>		Wired Controller	Wired Controller	Wired Controller

- Note:
1. Rated capacity at 0 ft. above sea level with 25 ft. of refrigerant line and a 0 ft. level difference between outdoor and indoor unit.
  2. Rated cooling capacity obtained with air entering the indoor unit at 80°F dry bulb (DB) and 67°F wet bulb (WB) and outdoor ambient conditions of 95°F dry bulb (DB) and 75°F wet bulb (WB).
  3. Rated heating capacity obtained with air entering the indoor unit at 70°F dry bulb (DB) and 60°F wet bulb (WB) and outdoor ambient conditions of 47°F dry bulb (DB) and 43°F wet bulb (WB).
  4. All power/communication wiring minimum 4-conductor, stranded, shielded, and must comply with applicable local and national codes.
  5. All LG wired controls are compatible and can be considered for control.
  6. Due to our commitment to continued innovation, some specifications may be changed without notification.

# MULTI F INDOOR UNITS



## High Static Ducted

Specification	Unit	LMHN240HV	LMHN360HV	
Capacity	Cooling	Btu/h	24,000	36,000
	Heating	Btu/h	27,000	40,000
Power	Voltage	V, Ø, Hz	208/230-1-63	208/230-1-64
	Power/Communication Wiring <sup>4</sup>	No. x AWG	4 x 18	4 x 18
Operating Range	Cooling	°F WB	57 - 77	57 - 77
	Heating	°F DB	59 - 81	59 - 81
Fan	Type		Sirocco	Sirocco
	Motor Output x Qty	W	154 x 1	350 x 1
	Motor/Drive		BLDC	BLDC
	Airflow (H/M/L) <sup>3</sup>	CFM	688/618/530	1,130/953/706
	Rated Amps	A	0.9	1.4
Unit Data	Factory Set External Static Pressure	in. wg	0.39	0.39
	Max. External Static Pressure	in. wg	0.78	0.55
	Sound Pressure Level (H/M/L) <sup>3</sup>	dB(A)	37/36/35	44/42/40
	Dimensions (WxHxD)	in	46-17/32 x 11-23/32 x 17-23/32	46-17/32 x 11-23/32 x 17-23/32
	Weight (Net/Shipping)	lbs	80/91	91/101
Piping	Liquid Pipe	in	1/4	3/8
	Vapor Pipe	in	1/2	5/8
	Drain (OD/ID)	in	1-1/4, 1	1-1/4, 1
Controller	Additional Accessory <sup>6</sup>		Wired Controller	Wired Controller

## Vertical AHU



Specification	Unit	UM180H/V4	UM240H/V4	UM360H/V4	UMVR360H/V	
Capacity	Cooling	Btu/h	18,000	24,000	36,000	36,000
	Heating	Btu/h	20,000	27,000	40,000	40,000
Power	Voltage	V, Ø, Hz	208/230-1-60	208/230-1-60	208/230-1-60	208/230-1-60
	Power/Communication Wiring <sup>5</sup>	No. x AWG	4 x 18	4 x 18	4 x 18	4 x 18
Operating Range	Cooling	°F WB	57 - 77	57 - 77	57 - 77	57 - 77
	Heating	°F DB	59 - 81	59 - 81	59 - 81	59 - 81
Fan	Type		Sirocco	Sirocco	Sirocco	Sirocco
	Motor Output x Qty	W	198 x 1	198 x 1	400 x 1	182 x 1
	Motor/Drive		BLDC	BLDC	BLDC	BLDC
	Airflow (H/M/L) <sup>3</sup>	CFM	640/580/480	710/640/480	1,100/1,000/900	990/880/800
	Rated Amps	A	1.1	1.1	2.2	1.12
Unit Data	Max. External Static Pressure	in. wg	0.7	0.7	1	1
	Sound Pressure Level (H/M/L) <sup>4</sup>	dB(A)	42/42/41	43/42/41	45/44/43	45/44/43
	Dimensions (WxHxD)	in	18 x 48-11/16 x 21-1/4	18 x 48-11/16 x 21-1/4	25 x 55-3/16 x 21-1/4	18 x 48-21/32 x 21-1/4
	Weight (Net/Shipping)	lbs	129/140	129/140	165/188	121/135
	Liquid Pipe	in	1/4	1/4	3/8	3/8
Piping	Vapor Pipe	in	1/2	1/2	5/8	5/8
	Drain	in	Primary & Secondary: 3/4 FPT	Primary & Secondary: 3/4 FPT	Primary & Secondary: 3/4 FPT	Primary & Secondary: 3/4 FPT
Controller	Additional Accessory <sup>6</sup>		Wired Controller	Wired Controller	Wired Controller	Wired Controller

**Note:**

1. Rated capacity at 0 ft. above sea level with 25 ft. of refrigerant line and a 0 ft. level difference between outdoor and indoor unit.
2. Rated cooling capacity obtained with air entering the indoor unit at 80°F dry bulb (DB) and 67°F wet bulb (WB) and outdoor ambient conditions of 95°F dry bulb (DB) and 75°F wet bulb (WB).
3. At 0.5" WG ESP.
4. Sound pressure levels are tested in an anechoic chamber under ISO Standard 3745 and are the same in both cooling and heating mode. These values can increase due to ambient conditions during operation.
5. All power/communication wiring minimum 4-conductor, stranded, shielded, and must comply with applicable local and national codes.
6. All LG wired controls are compatible and can be considered for control.
7. Due to our commitment to continued innovation, some specifications may be changed without notification.

# MULTI F MAX PIPING ACCESSORIES

## Accessory Lineup

For	2 IDUs	3 IDUs	4 IDUs	4 IDUs
Branch Distribution Unit	 PMBD3620	 PMBD3630	 PMBD3640	 PMBD3641
Y-Branch				

## Branch Distribution Unit Features

- Distribution of refrigerant to various indoor units
- 4 models (2, 3, 4 indoor units)
- Integral EEVs
- Controlling PCB inside the unit
- Internally insulated (prevents condensation)
- Flare joints for easy and clean installation
- Compact design (low height)
- Flexible installation

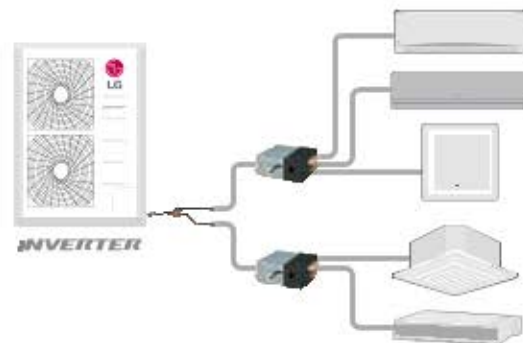

## Specifications

Specification		Unit	PMBD3620	PMBD3630	PMBD3640	PMBD3641
Max Nominal Port Capacity	Each Port	Btu/h	24,000	24,000	24,000	Ports A - C: 24,000 Port D: 36,000
	Sum of Ports	Btu/h	48,000	72,000	73,000	73,000
Connectable Indoor Units			1 - 2	1 - 3	1 - 4	1 - 4
Operating Range		°F DB	0 - 150	0 - 150	0 - 150	0 - 150
Voltage		V, ∅, Hz	208/230-1-60	208/230-1-60	208/230-1-60	208/230-1-60
Power Input		W	16	24	32	32
Rated Amps		A	0.08	0.12	0.16	0.16
Dimensions	WxD	inch	17-3/32 x 6-13/32 x 10-23/32	17-3/32 x 6-13/32 x 10-23/32	17-3/32 x 6-13/32 x 10-23/32	17-3/32 x 6-13/32 x 10-23/32
	Net	lbs	13	15	16	16
Weight	Shipping	lbs	15	17	18	18
	Pipe Connection Size (In from ODU)					
	Liquid	in	3/8	3/8	3/8	3/8
	Vapor	in	3/4	3/4	3/4	3/4
Pipe Connection Size (Out to IDU)	Liquid	in	1/4 (x2)	1/4 (x3)	1/4 (x4)	Ports A - C: 1/4 Port D: 1/4
	Vapor	in	3/8 (x2)	3/8 (x3)	3/8 (x4)	Ports A - C: 3/8 Port D: 1/2
Max Pipe Length	BD Box to IDU	ft	49.2	49.2	49.2	49.2
	BD Box to BD Box	ft	49.2	49.2	49.2	49.2

Note:

1. Branch Distribution Unit should be installed indoors.
2. Due to our commitment to continued innovation, some specifications may be changed without notification.



# MULTI F PIPING SUMMARY

The following are examples of manual pipe size calculations. Designers are strongly encouraged to use LATS for Multi F systems.

## Multi F System

Example shown: LMU36CHV outdoor unit with four (4) indoor units connected.

Model Number	Min Length Each Pipe (ft.)	Maximum Piping Length to each IDU (ft.)				Max. Total Piping Length For Each System (ft.)
		A	B	C	D	
LMU18CHV	10	82	82	-	-	164
LMU24CHV	10	82	82	82	-	246.1
LMU30CHV	10	82	82	82	82	246.1
LMU36CHV	10	82	82	82	82	246.1

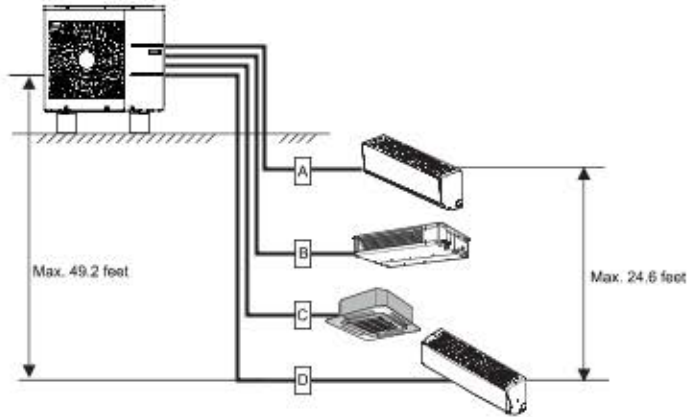

## Multi F MAX System

Example: LMU540HV outdoor unit with seven (7) indoor units, and two (2) branch distribution units connected.

A, B, C, D: Pipes from Outdoor Unit to Indoor Unit

Pipe Length (ELF = Equivalent Length of pipe in Feet)	Total System Pipe Length ( $\Sigma A + \Sigma B$ )		≤475.7 feet
	Main pipe (Outdoor Unit to Branch Distribution Units: $\Sigma A$ )	Minimum per segment	10 feet
		Maximum	≤180.4 feet
	Total Branch Pipe Length ( $\Sigma B$ )		≤295.3 feet
Elevation Differential (All Elevation Limitations are Measured in Actual Feet)	Branch pipe (Branch Distribution Units to Indoor Units: $\Sigma B$ )	Minimum	10 feet
		Maximum	≤49.2 feet
	If outdoor unit is above or below indoor unit ( $h1$ )		≤98.4 feet
	Between the farthest two indoor units ( $h2$ )		≤49.2 feet
	Between branch distribution unit and farthest connected indoor unit(s) ( $h3$ )		≤32.8 feet
Between branch distribution units ( $h4$ )		≤49.2 feet	

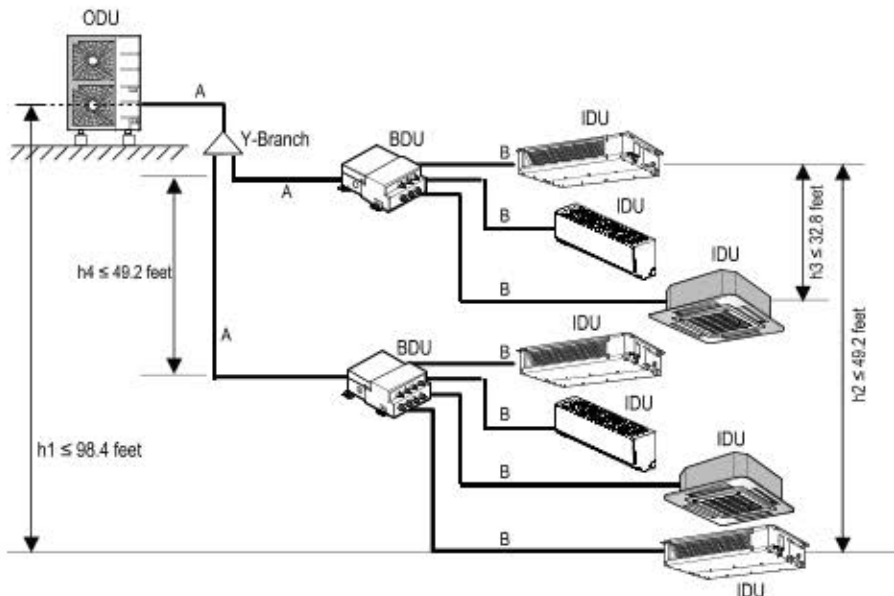

### KEY:

ODU: Outdoor Unit  
 IDU: Indoor Unit  
 BDU: Branch Distribution Unit (s)  
 A, B, C, D: Pipes from ODU to IDU

$\Sigma A$ : Main Pipe  
 $\Sigma B$ : Branch Pipe (BDU(s) to IDU(s))

# CONTROLS

## Individual Control



Model	Description
PREMTC00U	Simple Wired Remote Controller
PQWRHQ0FDB	Wireless Remote Controller
PREMTA000	Premium Wired Remote Controller
PREMTBVC0	LG MultiSITE™ Remote Controller
PREMTBVC1	LG MultiSITE™ Remote Controller with Occupancy Sensor
ZRTBS01	Remote Temperature Button Sensor

## LG MultiSITE™ Remote Controller Accessories



Model	Description
ZVRCZPWC1	ZigBee Pro Wireless Card
ZVRCZDWS1	Wireless Door & Window Switch
ZVRCZWOC1	Wireless Ceiling Mounted Occupancy Sensor
ZVRCZCOC1	Wireless Wall Mounted Occupancy Sensor

## Integration Devices



Model	Description
PBACNBTR0	LG MultiSITE™ Communications Manager
PDRYCB100	Simple Dry Contact
PDRYCB300	Dry Contact for Thermostat (5-12Vdc, 24Vac)
PDRYCB400	Dry Contact for Economizer/Setback
PLNWKB100	LonWorks® Gateway
PQNFB17C2	ACP BACnet® Gateway
PMNFP14A1	PI 485 for DFS
PZCWRC1	32.8' Wired Remote Extension Cable
PZCWRCG3	Group Control Cable Kit (required for each additional A/H with single zone controller)
PACP4B001	ACPIV
PACS4B000	AC Smart IV
PBACNA000	AC Smart BACnet® Gateway

# ACCESSORIES

## Indoor Accessories



PCRCUDT3  
PWFMD200



PRARH0  
PRARS1



PTEGM0



PTDCM  
PTDCQ



PT-QCHW0  
PT-UMC1  
PT-UQC



PTVK410



PTVK420



PTVK430



PTPKM0  
PTPKQ0



ANEH\*\*\*B1  
ANEH\*\*\*B2

Type	Model	Description	Used with
Wi-Fi Module	PCRCUDT3	Wi-Fi Module (for use with LG SmartThinQ™)	See Compatibility Table
	PWFMD200	Connects to CN_WF or CN_WIFI depending on how the unit's board is marked	See Compatibility Table
Aux Heater Relay Kit	PRARH0	Auxiliary Heat Kit for Cassettes & Ducted IDUs	See Compatibility Table
	PRARS1	Auxiliary Heat Kit for Wall Mounted IDUs	See Compatibility Table
Auto Elevation Grille	PTEGM0	Auto Elevation Grille Kit	LCN***HV <sup>1</sup>
Cassette Cover	PTDCM	Decorative Cover for 4-Way Ceiling Cassettes Using PT-UMC1 Grille	LCN***HV <sup>1</sup>
	PTDCQ	Decorative Cover for 4-Way Ceiling Cassettes Using PT-UQC Grille	LMCN***HV, LCN***HV4
Cassette Grille	PT-UMC1	4-Way Ceiling Cassette Matte Grille	LCN***HV <sup>1</sup>
	PT-UMC1B	4-Way Ceiling Cassette Black Grille	LCN***HV <sup>1</sup>
	PT-UQC	4-Way Ceiling Cassette Matte Grille	LMCN***HV, LCN***HV4
	PT-QCHW0	4-Way Ceiling Cassette 2X2 Matte Grille	LMCN***HV, LCN***HV4
Cassette Ventilation	PTVK410	Ventilation Air Intake Spacer for 4-Way Ceiling Cassettes (requires PTVK420)	LCN***HV <sup>1</sup>
	PTVK420	6" Ø Ventilation Air Connection for 4-Way Ceiling Cassettes (requires PTVK410)	LCN***HV <sup>1</sup>
	PTVK430	3" Ø Ventilation Air Connection for all 4-Way Ceiling Cassettes	All 4-Way Ceiling Cassettes
Plasma Filter Kit	PTPKM0	Plasma Filter Kit for 4-Way Ceiling Cassette	LCN***HV <sup>1</sup>
	PTPKQ0	Plasma Filter Kit for 4-Way Ceiling Cassette	LMCN***HV, LCN***HV4
VAHU Heat Kit	ANEH033B1	3 kW Electric Heat Kit for VAHU	LVN***HV4
	ANEH053B1	5 kW Electric Heat Kit for VAHU	LVN***HV4
	ANEH083B2	8 kW Electric Heat Kit for VAHU	LVN***HV4
	ANEH103B2	10 kW Electric Heat Kit for VAHU	LVN***HV4
	ANEH153B2	15 kW Electric Heat Kit for VAHU	LVN360HV4, LVN***HV
	ANEH203B2	20 kW Electric Heat Kit for VAHU	LVN360HV4, LVN***HV
VAHU Vertical Down Flow Conversion Kit	PNDFJ0	Vertical Down Flow Conversion Kit	LVN1B0HV4, LVN240HV4
	PNDFK0	Vertical Down Flow Conversion Kit	LVN360HV4, LVN***HV
HSD Filter Box	ZFBXBG01A	High-capacity filter box for BG HSD chassis	LMHN***HV, LHN247HV
	ZFBXBR01A	High-capacity filter box for BR HSD chassis	LHN367HV

Note

1. Accessory is not compatible with LCN\*\*\*HV4 models.

2. Due to our commitment to continued innovation, some specifications may be changed without notification.



# ACCESSORIES

## Outdoor Accessories



Base Pan Heater



Wind Baffle

Category	Model	Description	Used with
Wind Baffle	ZLABGP01A	Wind Baffle for Low Ambient Cooling	9kBtu & 12kBtu   HSV5, HYV1, LUU***HV
	ZLABGP02A	Wind Baffle for Low Ambient Cooling	15kBtu+   HYV1, HYV2, HSV5, HLV
	ZLABGP03A	Wind Baffle for Low Ambient Cooling	24kBtu   HSV3
	ZLABGP04A	Wind Baffle for Low Ambient Cooling	LMU18CHV, LMU24CHV LMU30CHV, LMU36CHV, LUU18*HV, LUU24*HV Multi F MAX, LUU36*HV, LUU42*HV, LUU48*HV <sup>1</sup>
Base Pan Heater	PQSH1200	Base Pan Heater for Multi F and Single Zone (Cassette & Ducted styles)	All Multi F and Multi F MAX Outdoor Units LUU18*HV, LUU24*HV, LUU36*HV, LUU42*HV, LUU48*HV <sup>2</sup>
	PQSH1201	Base Pan Heater for Single Zone (Wall Mounted styles)	LSU180HSV5, LAU240HSV3 <sup>3</sup> , LSU303HLV, LSU363HLV
	PQSH1202	Base Pan Heater for Single Zone (Cassette & Ducted styles)	LUU09*HV, LUU12*HV <sup>4</sup>

## Air Technologies



ARVU053ZEA2 / ARVU063ZEA2



ARVU093ZFA2 / ARVU123ZFA2



PSNFP14A0



PES-C0RV0

Category	Model	Description
ERV	ARVU053ZEA2	Energy Recovery Ventilator 465 cfm
	ARVU063ZEA2	Energy Recovery Ventilator 600 cfm
	ARVU093ZFA2	Energy Recovery Ventilator 900 cfm
	ARVU123ZFA2	Energy Recovery Ventilator 1,200 cfm
ERV Accessory	PSNFP14A0	PI485 for ERV (INDOOR)
	PES-C0RV0	CO <sub>2</sub> Sensor

**Note**

- Multi F MAX, LUU36\*HV, LUU42\*HV, and LUU48\*HV require Qty 2 of ZLABGP04A.
- Base Pan Heater is factory supplied for outdoor units featuring LGRED<sup>®</sup> heat and 9k and 12k Btu/h LSU\*\*\*HSV5 outdoor units
- Base Pan Heater is compatible with Multi F and Multi F MAX units manufactured after May 2015 and listed LUU\*\*\*HV models manufactured after April 2017.
- Only applicable with units manufactured after February 2018.
- Due to our commitment to continued innovation, some specifications may be changed without notification.

# CONTROLS & ACCESSORIES COMPATIBILITY

## Indoor Accessories

IDUs shown compatible with LG MultiSITE™ Remote Controllers (PREMTBVC1 / PREMTBVC0) are compatible with all LG wired controllers.



PCRCUDT3  
PWFMD0200



PREMTBVC1  
PREMTBVC0



PDRYCB100  
PDRYCB400  
PDRYCB300



ZRTBS01



PZCWRCG3  
PZCWRC1



PRARS1  
PRARH0

CONTROLS & ACCESSORIES

Single Zone		Wi-Fi Module <sup>1</sup>	Wi-Fi Module <sup>2</sup>	LG MultiSITE™ Remote Controllers	Dry Contact (Simple)	Dry Contact (Setback)	Dry Contact (Thermostat)	Remote Temp/ Button Sensor	Group Control	Cable Extension	Aux Heater Relay Kit	Aux Heater Relay Kit
		PCRCUDT3	PWFMD0200	PREMTBVC1 PREMTBVC0	PDRYCB100	PDRYCB400	PDRYCB300	ZRTBS01	PZCWRCG3	PZCWRC1	PRARS1	PRARH0
Mega	LS---HEV1	X	-	X	X	X	X	X	X	X	X	-
Mega 115V	LS---HXV	X	-	0	0	0	0	X	X	0	X	-
High Efficiency	LS---HSV5	Built-in	-	0	0	0	0	X	X	0	X	-
Longpipe	LS---3HLV	Built-in	-	0	0	0	0	X	X	0	X	-
Art Cool Mirror	LA---HSV5	Built-in	-	0	0	0	0	X	X	0	X	-
	LA240HSV3	X	-	0	0	0	0	X	X	0	X	-
Art Cool Premier	LA---HV1	0	-	0	0	0	0	X	X	0	X	-
	LA---HV2	0	-	0	0	0	0	X	X	0	X	-
Cassette	LC---HV4	-	0	0	0	0	0	0	0	0	-	0
	LC---HV	-	0	0	0	0	0	0	0	0	-	0
Ducted	LH---HV	-	0	0	0	0	0	0	0	0	-	0
	LD---HV4	-	0	0	0	0	0	0	0	0	-	0
Vertical AHU	LV---HV4	-	0	0	0	0	Built-in	0	0	0	-	0
	LV---HV	-	0	0	0	0	Built-in	0	0	0	-	0
Multi-Zone		Wi-Fi Module <sup>1</sup>	Wi-Fi Module <sup>2</sup>	LG MultiSITE™ Remote Controllers	Dry Contact (Simple)	Dry Contact (Setback)	Dry Contact (Thermostat)	Remote Temp/ Button Sensor	Group Control	Cable Extension	Aux Heater Relay Kit	Aux Heater Relay Kit
		PCRCUDT3	PWFMD0200	PREMTBVC1 PREMTBVC0	PDRYCB100	PDRYCB400	PDRYCB300	ZRTBS01	PZCWRCG3	PZCWRC1	PRARS1	PRARH0
High Efficiency	LMN079HVT	Built-in	-	0	0	0	0	X	0	0	0	-
	LSN090HSV5	Built-in	-	0	0	0	0	X	0	0	0	-
	LSN120HSV5	Built-in	-	0	0	0	0	X	0	0	0	-
	LMN159HVT	Built-in	-	0	0	0	0	X	0	0	0	-
	LSN180HSV5	Built-in	-	0	0	0	0	X	0	0	0	-
	LMN249HVT	Built-in	-	0	0	0	0	X	0	0	0	-
Art Cool Mirror	LAN090HSV5	Built-in	-	0	0	0	0	X	0	0	0	-
	LAN120HSV5	Built-in	-	0	0	0	0	X	0	0	0	-
	LAN180HSV5	Built-in	-	0	0	0	0	X	0	0	0	-
Art Cool Gallery	LMAN097HVP	-	-	0	0	0	0	X	0	0	0 <sup>3</sup>	-
	LMAN127HVP	-	-	0	0	0	0	X	0	0	0 <sup>3</sup>	-
Cassette	LMCN077HV	-	0	0	0	0	0	0	0	0	-	0
	LCN097HV4	-	0	0	0	0	0	0	0	0	-	0
	LCN127HV4	-	0	0	0	0	0	0	0	0	-	0
	LMCN185HV	-	0	0	0	0	0	0	0	0	-	0 <sup>2</sup>
Low Static Duct	LDN097HV4	-	0	0	0	0	0	0	0	0	-	0
	LDN127HV4	-	0	0	0	0	0	0	0	0	-	0
	LMDN186HV	-	0	0	0	0	0	0	0	0	-	0
High Static Duct	LMHN240HV	-	X	0	0	0	0	0	0	0	-	0
	LMHN360HV	-	X	0	0	0	0	0	0	0	-	0
Vertical AHU	LVN180HV4	-	0	0	0	0	Built-in	0	0	0	-	0
	LVN240HV4	-	0	0	0	0	Built-in	0	0	0	-	0
	LVN360HV4	-	0	0	0	0	Built-in	0	0	0	-	0
	LMVN360HV	-	X	0	0	0	0	0	0	0	-	0

Note:

"0" in a cell indicates available; "X" indicates not available; "-" indicates not applicable.

Some IDUs have a control wire terminal block to connect a wired controller with field-supplied control cable instead of the LG control cable (with Molex connection). See IDU engineering manual or installation manual for details.

1. Emergency Heat function is not available with Aux Heat Relay Kit.

2. Aux Heat Relay Kit is applicable for models produced after June 2014.

3. LG is committed to expanding Wi-Fi Module compatibility throughout our products. For the most updated Wi-Fi Module compatibility chart, please visit [www.lg-dfs.com](http://www.lg-dfs.com)

4. Due to our commitment to continued innovation, some specifications may be changed without notification.

# CONTROLS & ACCESSORIES COMPATIBILITY

## Outdoor Accessories & Service Accessories



PBACNBTR0A



PMNFP14A1



PACS4B000  
PBACNA000



PACP4B001



PQNFBI7C2



PLNWKB100



PSWMOZ3



PLGMVW100

Single Zone		P4B5 for ODU	PDI Premium & Standard	AC Smart IV Central Control	ACP IV Central Control	LG MultiSITE™ Communication Manager	AC Smart BACnet®	ACP IV BACnet®	ACP LonWorks®	LG SIMS	LGMV Hard Lock Key & Cable	Mobile LGMV®
		PWNFP14A1	POMJD15A1 PPWR09000	PACS4B000	PACP4B001	PBACNBTR0A	PBACNA000	PQNFBI7C2	PLNWKB100	PSWMOZ3	PACTILO	PLGMVW100
<b>Mega</b>	LS---HEV1	X	X	X	X	X	X	X	X	0	0	X
<b>Mega 115V</b>	LS---HV	X	X	X	X	X	X	X	X	0	0	X
<b>Standard</b>	LS---HSV5	0	0	0	0	0	0	0	0	0	0	X
<b>Longpipe</b>	LS---HLV	0	0	0	0	0	0	0	0	0	0	X
<b>Art Cool</b>	LA---HSV5	0	0	0	0	0	0	0	0	0	0	X
<b>Mirror</b>	LA240HSV3	0	0	0	0	0	0	0	0	0	0	X
<b>Art Cool Premier</b>	LA090HYV1 LA120HYV1	X	X	X	X	X	X	X	X	0	0	X
	LA180HYV1 LA240HYV1	0	0	0	0	0	0	0	0	0	0	X
	LA---HYV2	0	0	0	0	0	0	0	0	0	0	X
<b>Cassette</b>	LC---HV4	0	0	0	0	0	0	0	0	0	0	X
	LC---HV	0	0	0	0	0	0	0	0	0	0	X
<b>Ducted</b>	LH---HV	0	0	0	0	0	0	0	0	0	0	X
	LD---HV4	0	0	0	0	0	0	0	0	0	0	X
<b>Vertical AHU</b>	LV---HV4	0	0	0	0	0	0	0	0	0	0	X
	LV---HV	0	0	0	0	0	0	0	0	0	0	X
Multi-Zone		P4B5 for ODU	PDI Premium & Standard	AC Smart IV Central Control	ACP IV Central Control	MultiSITE™ Communication Manager	AC Smart BACnet®	ACP IV BACnet®	ACP LonWorks®	LG SIMS	LGMV Hard Lock Key & Cable	Mobile LGMV®
		PWNFP14A1	POMJD15A1 PPWR09000	PACS4B000	PACP4B001	PBACNBTR0A	PBACNA000	PQNFBI7C2	PLNWKB100	PSWMOZ3	PACTILO	PLGMVW100
<b>Multi F</b>	LMU18CHV	0	0	0	0	0	0	0	0	0	0	0
	LMU180HV	0	0	0	0	0	0	0	0	0	0	0
	LMU24CHV	0	0	0	0	0	0	0	0	0	0	0
	LMU240HHV	0	0	0	0	0	0	0	0	0	0	0
	LMU30CHV	0	0	0	0	0	0	0	0	0	0	0
	LMU300HHV	0	0	0	0	0	0	0	0	0	0	0
	LMU36CHV	0	0	0	0	0	0	0	0	0	0	0
<b>Multi F MAX</b>	LMU360HHV	0	0	0	0	0	0	0	0	0	0	0
	LMU420HHV	0	0	0	0	0	0	0	0	0	0	0
	LMU480HV	0	0	0	0	0	0	0	0	0	0	0
	LMU540HV	0	0	0	0	0	0	0	0	0	0	0
	LMU600HV	0	0	0	0	0	0	0	0	0	0	0

Note:

"0" in a cell indicates available; "X" indicates not available; "-" indicates not applicable

1. Mobile LGMV consists of the wifi module with connecting cable (PLGMVW100) and the LGMV App running on an Android device (smartphone or tablet).

2. Due to our commitment to continued innovation, some specifications may be changed without notification.



# ENERGY STAR® SYSTEMS

With several models winning the ENERGY STAR® Most Efficient designation, LG Air Conditioning Systems have industry-leading SEER and HSPF ratings.



## Single Zone Systems

AHRI Reference Number	Outdoor	Indoor	EER 95° F	SEER	HSPF	Most Efficient <sup>1</sup>
7947563	LAU090-HV1	LAN090-HV1	15.65	27.50	12.00	★
7849625	LAU120-HV1	LAN120-HV1	13.80	25.50	12.00	★
9680935	LAU150-HV2	LAN150-HV2	13.50	24.00	12.50	★
8584525	LAU180-HV1	LAN180-HV1	13.50	24.00	12.50	★
9680934	LAU180-HV2	LAN180-HV2	12.50	22.00	12.00	★
8584526	LAU240-HV1	LAN240-HV1	12.50	22.00	12.00	★
10567393	LSU090HSv5	LSN090HSv5	14.50	23.50	11.30	★
10570122	LSU120HSv5	LSN120HSv5	12.50	22.70	11.40	★
10567390	LSU180HSv5	LSN180HSv5	12.60	21.50	10.20	★
10567394	LSU090HSv5	LSN090HSv5	14.50	23.50	11.30	★
10570123	LSU120HSv5	LSN120HSv5	12.50	22.70	11.40	★
10567391	LSU180HSv5	LSN180HSv5	12.60	21.50	10.20	★
9122552	LSU243HDV	LSN243HDV	12.50	21.50	11.00	★
8032527	LSU090HEV1	LSN090HEV1	12.50	19.00	9.00	
8931560	LUU097HV	LCN097HV4	13.65	20.20	10.50	
8905114	LUU127HV	LCN127HV4	12.60	19.40	10.40	
5859619	LUU167HV	LCN167HV	15.00	20.00	10.10	
5584107	LUU247HV	LCN247HV	12.60	17.00	9.70	
5859620	LUU367HV	LCN367HV	13.50	19.00	9.50	
10513886	LUU188HV	LVN180HV4	13.30	19.00	9.50	
10513887	LUU248HV	LVN240HV4	12.50	18.00	10.00	
10399150	LUU369HV	LVN360HV4	12.50	18.00	10.00	

## Multi-Zone Systems

AHRI Reference Number	Outdoor	Indoor	EER 95° F	SEER	HSPF
7180060	LMU19CHV	Non-Ducted Indoor Units	13.00	22.00	9.70
10445372	LMU180HV	Non-Ducted Indoor Units	13.50	21.00	10.00
7180062	LMU24CHV	Non-Ducted Indoor Units	13.50	21.70	10.60
7184507	LMU24CHV	Mixed Ducted and Non-ducted Indoor Units	12.50	19.60	10.20
10445374	LMU240HV	Non-Ducted Indoor Units	13.50	21.00	10.70
8111355	LMU30CHV	Non-Ducted Indoor Units	13.00	22.00	10.00
10445376	LMU300HV	Non-Ducted Indoor Units	12.50	20.00	11.00
7180063	LMU36CHV	Non-Ducted Indoor Units	13.00	22.00	10.00
10443472	LMU360HV	Non-Ducted Indoor Units	15.00	21.00	11.50
10443475	LMU360HV	Ducted Indoor Units	13.50	17.50	10.50
10443471	LMU420HV	Non-Ducted Indoor Units	14.00	20.50	11.00
10443474	LMU420HV	Ducted Indoor Units	13.00	19.00	10.50
8111358	LMU480HV	Non-Ducted Indoor Units	12.50	19.50	10.00

Note:

1. Indicates unit is listed as ENERGY STAR® Most Efficient 2019. List is current as of January 2019. For the most up-to-date list of ENERGY STAR® and ENERGY STAR® Most Efficient models, visit the AHRI Directory at [ahridirectory.org](http://ahridirectory.org).



ENERGY STAR® is a joint program of the U.S. Environmental Protection Agency (EPA) and the U.S. Department of Energy (DOE) created to promote energy-efficient products and practices. The ENERGY STAR® logo helps homeowners identify which products meet energy efficiency performance levels set by U.S. EPA and U.S. DOE.

Select LG air conditioning systems may make homeowners eligible for equipment-related tax benefits and credits. Visit [rebates.lghvac.com](http://rebates.lghvac.com) to see if your LG air conditioning system qualifies.

# HOW TO READ LG MODEL NUMBERS

## SINGLE ZONE SYSTEMS – INDOOR/OUTDOOR

<b>L</b>	<b>A</b>	<b>N</b>	<b>09</b>	<b>0</b>	<b>H</b>	<b>YV</b>	<b>1</b>
Brand	Family	Component	Nominal Capacity	Generation	Cycle	Product Type	Features

<b>Brand</b>	<b>L</b>	LG					
<b>Family</b>	<b>A</b>	Art Cool™ Wall Mounted			<b>H</b>	Ceiling-Concealed Duct (High Static)	
	<b>C</b>	Four-Way Ceiling Cassette			<b>S</b>	Standard Wall Mounted	
	<b>D</b>	Ceiling-Concealed Duct (Low Static)			<b>U</b>	Cassette/Duct ODU	
					<b>V</b>	Vertical Air Handling Unit	
<b>Component</b>	<b>N</b>	Indoor Unit			<b>U</b>	Outdoor Unit	
<b>Nominal Capacity</b>	<b>09</b>	9,000			<b>24</b>	24,000	
	<b>12</b>	12,000			<b>30</b>	30,000	
	<b>15</b>	15,000			<b>36</b>	36,000	
	<b>18</b>	18,000			<b>42</b>	42,000	
					<b>48</b>	48,000	
<b>Generation</b>	<b>0-8</b>						
<b>Cycle</b>	<b>H</b>	Heat Pump					
<b>Product Type</b>	<b>EV</b>	Mega Inverter			<b>V</b>	Standard Inverter	
	<b>LV</b>	Extended Pipe Inverter			<b>XV</b>	Mega 115V Inverter	
	<b>SV</b>	Art Cool™ Mirror Inverter & High-Efficiency Inverter			<b>YV</b>	Art Cool™ Premier Inverter	
<b>Features</b>	<b>1-2-3-4-5</b>	Model-Specific Features/Improvements					

## MULTI-ZONE SYSTEMS – INDOOR/OUTDOOR<sup>1</sup>

<b>L</b>	<b>M</b>	<b>N</b>	<b>15</b>	<b>9</b>	<b>HV</b>	<b>T</b>
Brand	Family	Product	Nominal Capacity	Generation	Cycle/Type	Style

<b>Brand</b>	<b>L</b>	LG				
<b>Family</b>	<b>M</b>	Multi-Zone				
<b>Product</b>	<b>AN</b>	Art Cool™ Wall Mounted Indoor Unit			<b>N</b>	Standard Wall Mounted Indoor Unit
	<b>CN</b>	Four-Way Ceiling-Cassette Indoor Unit			<b>VN</b>	Vertical-Horizontal Air Handling Indoor Unit
	<b>DN</b>	Ceiling-Concealed Duct (Low Static) Indoor Unit			<b>U</b>	Outdoor Unit
	<b>HN</b>	Ceiling-Concealed Duct (High Static) Indoor Unit				
<b>Nominal Capacity</b>	<b>07</b>	7,000			<b>30</b>	30,000
	<b>09</b>	9,000			<b>36</b>	36,000
	<b>12</b>	12,000			<b>24</b>	24,000
	<b>15</b>	15,000			<b>48</b>	48,000
	<b>18</b>	18,000			<b>54</b>	54,000
	<b>24</b>	24,000			<b>60</b>	60,000
<b>Generation</b>	<b>0-5-6-7-8-9-C</b>					
<b>Cycle/Type</b>	<b>HV</b>	Inverter Heat Pump			<b>HHV</b>	High Heat (LGRED®) Inverter Heat Pump
<b>Style</b>	<b>P</b>	Art Cool™ Gallery IDU			<b>T</b>	High Wall IDU

Note:

1. Multi-compatible Single Zone IDU nomenclature is conveyed in the Single Zone Systems Section.

# NOTES

---

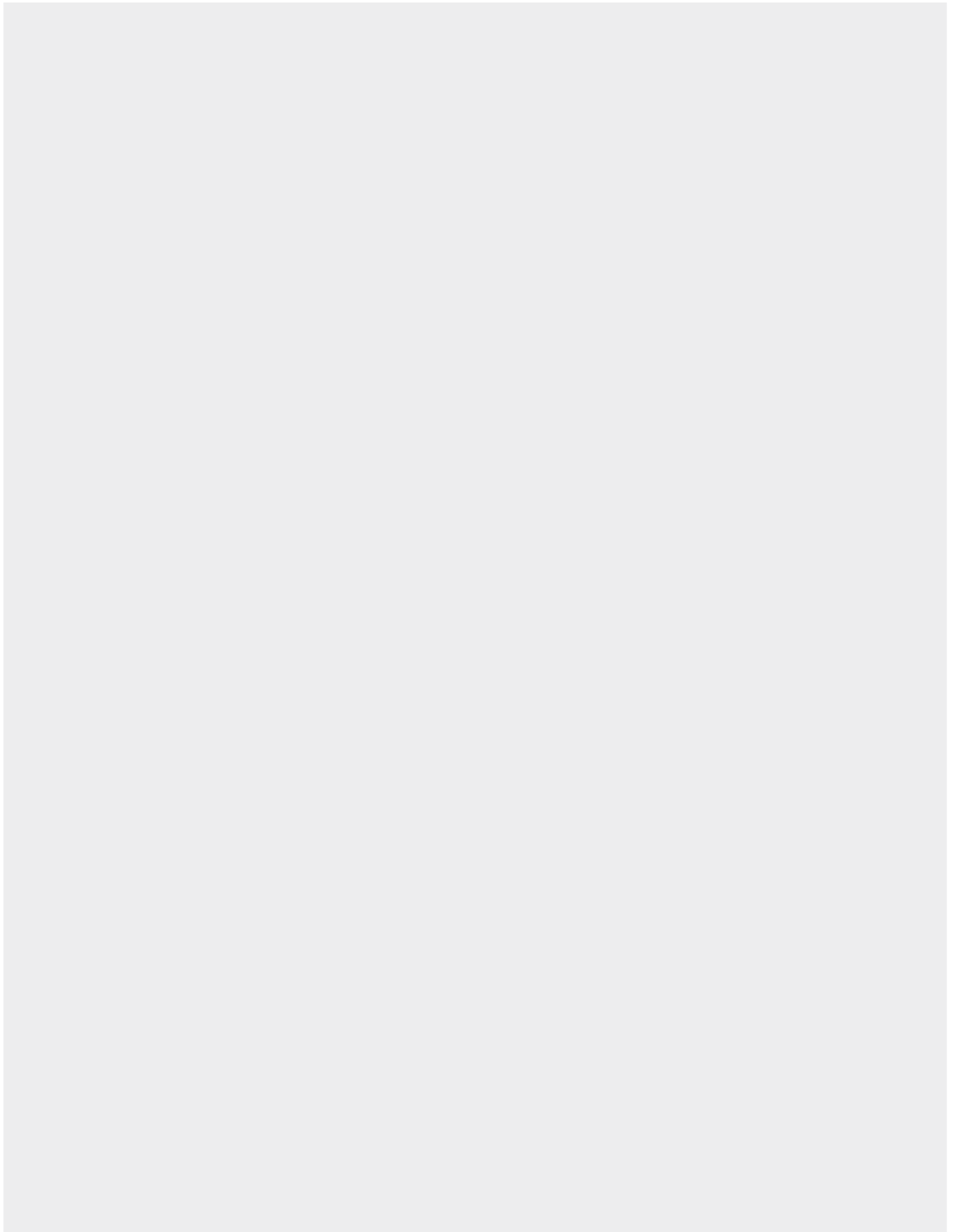



# NOTES

---

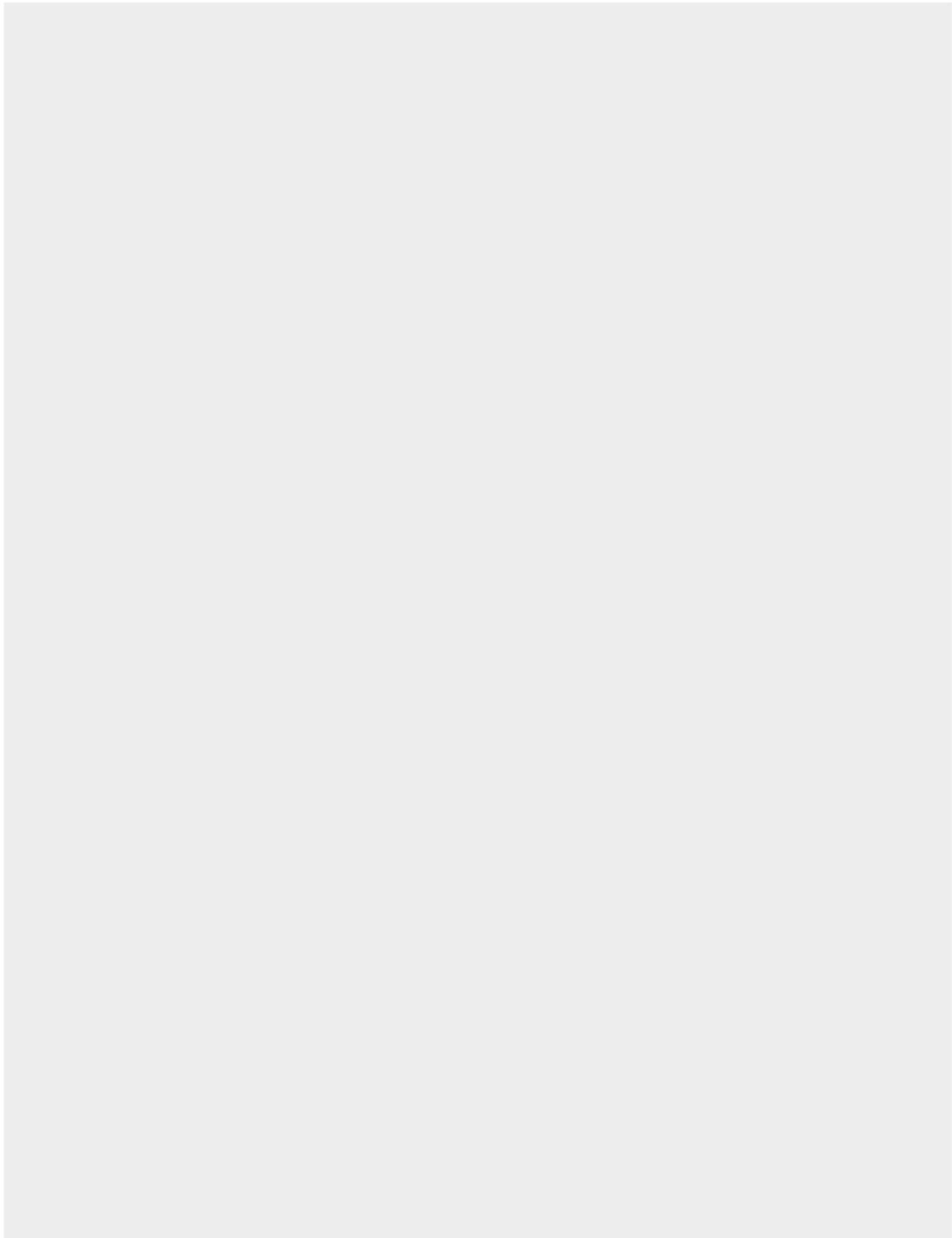

# NOTES

---

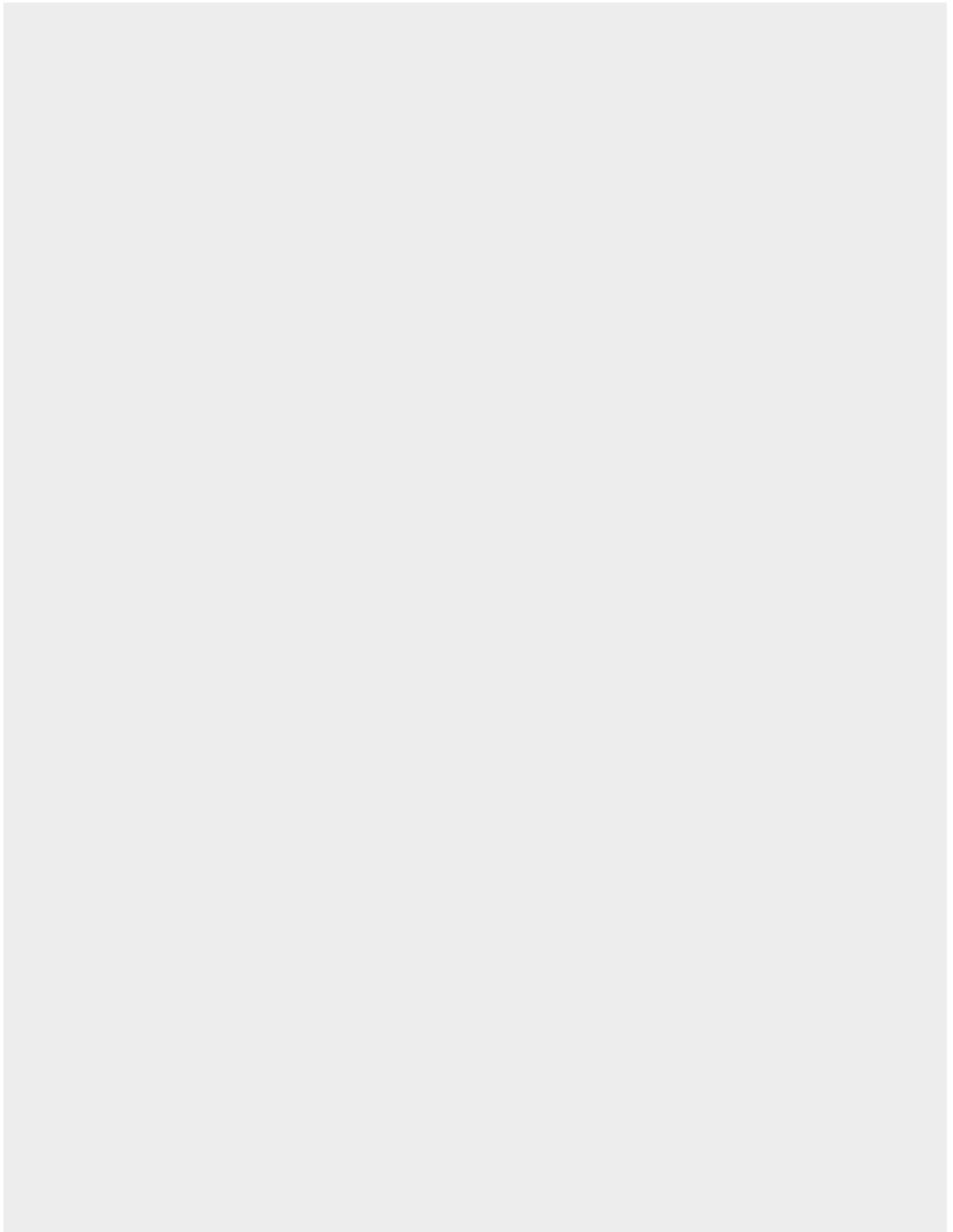



## LG Electronics USA, Inc.

Air Conditioning Technologies

4300 North Point Parkway, Alpharetta, GA 30022

[www.lghvac.com](http://www.lghvac.com)

Distributed by